



AI LIGHTS
LATTI

2017

AI LIGHTS
LATI

2017

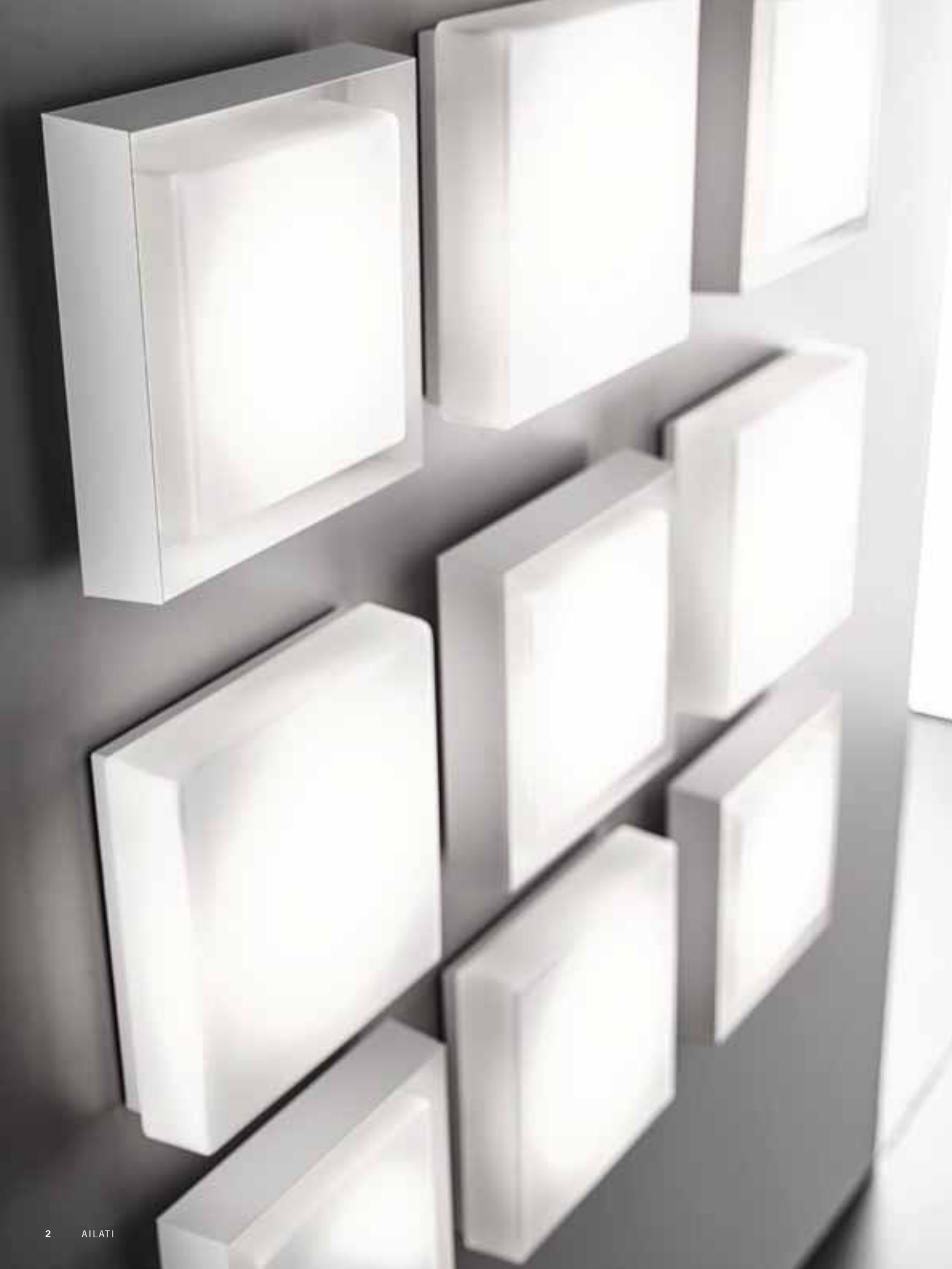



La nostra filosofia ci porta a coniugare i requisiti di efficienza di un corpo illuminante:

- semplicità e velocità di assemblaggio fra elemento di sospensione o ancoraggio, portacomponenti e diffusore;
- sorgenti a basso consumo e lunga durata
- alto grado di protezione
- linee semplici e concrete che garantiscono la durata anche di fronte al cambiamento delle tendenze

Va ancora sottolineato che per una reale economia di gestione, quando i corpi illuminanti vengono installati in numero elevato, il grado di protezione è indispensabile non solo all'esterno o negli ambienti umidi, ma anche nelle normali zone abitative e di transito.

Our design philosophy is to combine all the requisites of efficiency in one single luminaire:

- *easy and quick assembly between the suspension or anchoring element, component cover canopy and lampshade*
- *low-consumption, long-life light sources*
- *high degree of protection*
- *simple and solid lines that ensure long design life even through changing trends.*

It should be further highlighted that for real operating economy, when a large number of lamps are installed, the degree of protection is an indispensable feature not just in exteriors or high-humidity environments, but also in normal residential and transit areas.

Unsere Philosophie sieht vor, die Effizienzanforderungen eines Leuchtkörpers miteinander zu verbinden:

- *einfacher und schneller Zusammenbau von Hängeelement und Verankerung, Lampenkörper und Streukörper*
- *Energiesparleuchtmittel mit langer Lebensdauer*
- *hohe Schutzart*
- *schlichte und konkrete Linien, die trotz der Entwicklung neuer Trends immer aktuell sind.*

Noch ein wichtiger Hinweis: wenn die Leuchtkörper in großer Zahl installiert werden, ist das Erreichen der Schutzart für einen wirklich wirtschaftlichen Betrieb nicht nur im Freien oder in Feuchträumen erforderlich, sondern auch in normalen Wohn- und Durchgangsbereichen.

Notre philosophie nous conduit à conjuguer les qualités d'efficacité d'un corps illuminant:

- *simplicité et rapidité d'assemblage entre l'élément de suspension ou de fixation, le porte-composants et le diffuseur;*
- *sources à faible consommation et longue durée*
- *haut niveau de protection*
- *lignes simples et concrètes qui garantissent la durée même face au changement des tendances*

Il nous faut aussi souligner que pour une réelle économie de gestion, quand les corps illuminants sont installés en grande quantité, le niveau de protection est indispensable non seulement à l'extérieur ou dans les environnements humides, mais aussi dans les zones d'habitation normales et de transit.

Nuestra filosofía nos lleva a combinar los requisitos de eficiencia de un cuerpo iluminante:

- *sencillez y velocidad de ensamblado entre el elemento de suspensión o anclaje, porta componentes y difusor*
- *fuentes con bajo consumo y larga vida*
- *elevado nivel de protección*
- *líneas sencillas y concretas que garantizan su permanencia en el tiempo aún frente a los cambios de tendencia*

Una vez más cabe destacar que, para una real economía de gestión, frente a numerosos cuerpos iluminantes instalados, el nivel de protección es indispensable no sólo en las zonas exteriores o en los ambientes húmedos, sino también en las zonas habitacionales y de tránsito.

Federico de Majo

IL VETRO SOFFIATO TRIPLEX INCONTRA LA FONTE LUMINOSA A LED

La specialità di Ailati è il vetro opalino incamiciato a tre strati. Questo tipo di vetro, a differenza dei normali vetri soffiati in opalino duplex, ha una capacità di diffondere la luce molto più elevata. Infatti, lo strato di opale è molto sottile e inserito all'interno di due strati di vetro trasparente. L'abbattimento dei lumen risulta minore e permette una diffusione della luce maggiore ed omogenea. L'incontro di questo tipo di diffusore con la fonte luminosa LED è la specifica proposta di Ailati, che permette di abbinare una ottima qualità del vetro con una fonte di illuminazione tecnologicamente avanzata. La nuova collezione di plafoniere e lampade a LED del catalogo Ailati incrementa ulteriormente le caratteristiche tecniche del LED, trovando il perfetto connubio tra la migliore sorgente luminosa presente sul mercato e il vetro opalino di altissima qualità e design. La collezione nasce da un progetto di ricerca focalizzato ad ottenere massima omogeneità di illuminazione sul vetro opale ed ottimizzare il flusso luminoso dei LED, ben dimensionando il carico termico massimo gestibile all'interno della lampada. Queste considerazioni hanno portato alla progettazione di una famiglia di prodotti a LED: facili da installare > con bassa manutenzione e lunga durata > a basso consumo. Le schede LED da 25 W, particolarmente evolute, presentano vari sistemi di accensione, **su richiesta**: a piena potenza (versione standard) > doppia accensione > dimmerabile > **in emergenza integrato**. I prodotti a listino sono presenti nella versione con funzionamento a tensione di rete **220-240V AC**. Ciascuno di essi è ordinabile anche in versione **24V DC** per installazioni in cui la versione in bassa tensione rappresenti una soluzione progettuale conveniente. Tutti i prodotti sono progettati per assicurare un alto flusso luminoso, pur mantenendo il LED nelle migliori condizioni di funzionamento, tenuto conto delle dimensioni delle lampade e della potenza elettrica assorbita da scheda ed alimentatore. Per far questo Ailati si è avvalsa della collaborazione di professionisti del settore per garantire sia progettazioni di alto livello sia la massima qualità e durata dei prodotti LED. In particolare, per le plafoniere si è scelta la progettazione di una scheda LED "ad hoc", evitando le soluzioni commerciali poco adatte allo standard qualitativo richiesto dai prodotti Ailati. La progettazione ha portato alla concezione di una scheda con un'omogenea distribuzione dei LED sulla sua superficie, pilotabile anche in bassissima tensione (24VDC). La scelta della distribuzione dei LED è venuta da sé, vista l'omogeneità dell'illuminazione richiesta sui vetri delle plafoniere da illuminare, mentre la scelta dei 24V racchiude alcune sfumature tecniche che una scheda pilotata in corrente non possiede: uno stadio di ingresso in grado di proteggere i LED dall'incauta inversione di polarità e da picchi di tensione sull'ingresso della scheda; un bilanciamento della corrente di alimentazione sui vari rami in modo da evitare la prematura morte di tutta la scheda in caso di malfunzionamento di un LED; la possibilità di utilizzare la lampada in maniera nativa a 24V nelle applicazioni in cui la bassissima tensione è preferibile, se non addirittura richiesta dalla normativa. La scheda, inoltre, presenta due ingressi separati per permettere l'utilizzo con doppia accensione (l'ingresso secondario assorbe una potenza pari ad ¼ del primario) o utilizzando il secondario per il funzionamento in emergenza della lampada. **La scheda LED così progettata ha subito una serie di rigide verifiche termiche che ne garantiscono un'affidabilità di almeno tre anni.** Per quanto riguarda la sorgente LED vera e propria è utilizzato il LED che presenta un ottimo rapporto flusso/potenza ed un'ottima resa cromatica nelle temperature colore 3000K, e su richiesta 2700/4000K.

TRIPLEX BLOWN GLASS COMBINED WITH A LED LIGHT SOURCE

A specialty of Ailati is the three-ply cased opal glass. This type of glass, unlike ordinary duplex opal blown glass, has a capacity to spread light much higher. In fact, the white layer is very thin and inserted inside two layers of clear glass. In this case, the reduction of the lumen is smaller and allows greater and best uniform light.

Using this type of diffuser with a LED light source is a lighting solution from Ailati that combines very good quality glass with a cutting-edge light source.

*The new collection of ceiling lamps and LED lamps in the Ailati catalogue increases even further the technical characteristics of LED, finding the perfect alliance between the best light source available on the market and opal white glass of the highest quality and design. The collection originated from a research project that focused on obtaining the best homogeneity of illumination on opal glass and optimizing the light flux of the LEDs, balancing the maximum heat load that can be managed inside a lamp. These considerations have led to the designing of a whole family of LED products: easy to install > low maintenance and long life > low energy consumption. The 25W LED boards, particularly advanced, have various switch-on systems, **upon request**: on full power (standard version) > double switch-on > dimmable > **'in emergency' function integrated.***

*The products in the Ailati catalogue come in a version with an operating voltage of **220-240V AC**. They are also available in a **24V DC** version for installations where a low voltage version is a cost-effective design solution. All the products are designed to guarantee a high luminous flux while maintaining the LED light in the best operating conditions, taking into account the different sizes of the lamps and the electrical power absorbed by the LED board and the power adaptor. With the collaboration of professional suppliers in the sector, Ailati guarantees top-level designs and maximum quality and life for LED products. For the ceiling lamps, in particular, an "ad hoc" LED board design was chosen, avoiding the solutions available on the market that are ill-suited to the quality standards required by Ailati products. The design involved creating a LED board with a uniform distribution of LEDs on its surface, which could be powered at a low voltage (24V DC). A spontaneous choice was made for LED distribution, since the most uniform light output was required for the glass parts of the ceiling lamps to be illuminated, whereas 24V power was chosen because it has several technical nuances that a powered board does not have: an input stage that protects LEDs from inadvertent reverse polarity and from voltage spikes on the board input; a balanced power supply to various branches to prevent the premature end of life of the entire board if a LED should fail to function; the opportunity to install the lamp in direct 24V low-voltage applications, if not even required by regulations. In addition, the board has two separate inputs to allow use with a dual switch function (the secondary input absorbs a quarter of the power of the primary input) or to use the secondary input for emergency operation of the lamp. **The LED board designed in this way has undergone a series of stringent thermal tests that guarantee its reliability for at least three years.** For the real LED light source, a LED has been used that has an optimum flow/power ratio and excellent colour rendering for colour temperatures 3000K, and 2700/4000K on request.*



DAS GEBLASENE TRIPLEX GLAS TRIFFT DIE LED-LICHTQUELLE

Die Besonderheit von Ailati ist das ummantelte geblasene Opalglas Triplex. Diese Art von Glas unterscheidet sich von den klassischen Duplex geblasenen Glasarten, in dem sie eine intensivere Ausströmung des Lichtes ermöglicht. Grund dafür ist eine dünnere Glaslackierung, die zwischen zwei durchsichtige Kristallgläsern eingesetzt wird. Dadurch ist eine Schwächung der Lumen geringer und das Licht wird ein intensiver und homogener Schimmer. Diese Art von Diffusor mit der LED-Lichtquelle ist was Ailati vorzuschlagen hat: eine Kombination aus hochwertiger Glasqualität und einer Lichtquelle mit den modernsten technischen Eigenschaften. In unserem Katalog können Sie gerne verschiedene Modelle finden, die von einfachen linearen geometrischen Formen charakterisiert sind: sie bewahren aber immerhin einen ewigen Wert und können mit den verschiedensten Stilen und Formen kombiniert werden. Bei der neuen Kollektion der Deckenleuchten und LED-Leuchten des Katalogs Ailati steigern sich die technischen Eigenschaften der LEDs nochmals, da die beste auf dem Markt erhältliche Lichtquelle, hochwertiges Opalglas und Design perfekt miteinander kombiniert werden. Die Kollektion basiert auf einem Forschungsprojekt mit dem Ziel, auf Opalglas eine optimale homogene Beleuchtung zu erzeugen und den Lichtfluss der LEDs zu optimieren, indem die maximal in der Lampe auftretende Wärmelast richtig dimensioniert wird. Diese Überlegungen haben zur Entwicklung einer LED-Produktfamilie geführt, die: leicht zu installieren - wartungsfreundlich und langlebig - energiesparend ist. Die hochentwickelten 25 W LED-Platinen haben verschiedene Einschaltssysteme, **auf Wunsch**: mit voller Leistung (Standardversion) - 2-fache Einschaltung - dimmbar - **integrierte Noteinschaltung**. Die Produkte in der Preisliste sind in der Version für den Betrieb mit **220-240V AC** Netzspannung erhältlich. Die Produkte können jedoch auch in der Version mit **24V DC** bestellt werden, für Installationen, bei denen die Ausführung in Niederspannung eine vorteilhafte Lösung bei der Planung darstellt. Alle Produkte sind entwickelt, um einen hohen Lichtfluss zu garantieren, wobei für die LEDs, unter Berücksichtigung der Abmessungen der Leuchten und der elektrischen Leistungsaufnahme von Platine und Netzteil, optimale Betriebsbedingungen bestehen. Um dies zu erreichen, hat Ailati mit Branchenprofis zusammengearbeitet, um Planung auf hohem Niveau sowie höchste Qualität und Lebensdauer der LED-Produkte zu garantieren. Insbesondere bei den Deckenleuchten fiel die Entscheidung zugunsten der Entwicklung einer "ad hoc" LED-Platine, um nicht auf handelsübliche Lösungen zurückgreifen zu müssen, die den von den Ailati Produkten geforderten Qualitätsstandard nicht erfüllen. Die Entwicklung führte zur Konzipierung einer LED-Platine, bei der die LEDs gleichmäßig auf der Oberfläche verteilt sind und die in Niederspannung (24V DC) angesteuert werden kann. Die Anordnung der LEDs ergibt sich von selbst aus der Tatsache, dass auf den Gläsern der zu beleuchtenden Deckenleuchten eine hohe Gleichmäßigkeit der Beleuchtung erforderlich ist, während die Auswahl der 24V auf einigen technischen Details beruht, die eine stromgesteuerte Platine nicht besitzt: eine Eingangsstufe, die in der Lage ist, die LEDs vor leuchtender Polaritätsumkehr und vor Spannungsspitzen am Eingang der Platine zu schützen; Ausgleichung des Versorgungsstroms in den verschiedenen Zweigen, um bei Defekt einer LED den vorzeitigen Ausfall der gesamten Platine zu vermeiden; Möglichkeit zur Nutzung der Lampe im eigentlichen 24V-Betrieb für Anwendungen, bei denen Niederspannung zu bevorzugen, wenn nicht sogar von den Vorschriften gefordert ist. Die Platine besitzt ferner 2 separate Eingänge für die Nutzung der 2-fachen Einschaltung (der sekundäre Eingang nimmt ¼ der Leistung des primären Eingangs auf) oder um den sekundären Eingang für den Notbetrieb der Lampe zu nutzen. Die so entwickelte Hochwertige Koreanische **LED-Platine wurde einer Reihe von strengen thermischen Prüfungen unterzogen, die ihre Zuverlässigkeit für mindestens 3 Jahre** die ein ausgezeichnetes Lichtfluss/Leistungs-Verhältnis und bei Farbtemperaturen von 3000K und 2700/4000K eine hervorragende Farbleistung bietet.

LE VERRE SOUFFLÉ EN TRIPLEX RENCONTRE LA SOURCE LUMINEUSE À LED

La spécialité de Ailati est le verre opalin superposé incamiciato à trois couches. Ce type de verre, à la différence des verres normaux soufflés en opaline Duplex, a une capacité de diffusion de la lumière très élevée. En effet, la couche de verre blanc est très fine et elle est insérée à l'intérieur de deux couches de verre transparent. Dans ce cas, l'abaissement des lumens est moindre et permet une diffusion de la lumière majeure et homogène. La rencontre de ce type de diffuseur avec la source lumineuse à LED est la proposition spécifique de Ailati qui permet d'associer une qualité de verre optimale à une source d'illumination technologiquement avancée. La nouvelle collection de plafonniers et de lampes à LED du catalogue Ailati développe ultérieurement les caractéristiques techniques du LED, trouvant l'alliance parfaite entre la meilleure source lumineuse présente sur le marché et le verre opalin de très grande qualité et design. La collection naît d'un projet de recherche focalisé sur l'obtention d'une meilleure homogénéité d'illumination sur le verre opalin et sur l'optimisation du flux lumineux des LED, dimensionnant correctement la charge thermique maximale gérable à l'intérieur de la lampe. Ces considérations ont porté à la conception d'une famille de produits à LED: faciles à installer > avec peu d'entretien et longue durée > faible consommation. Les fiches LED de 25 W, particulièrement évoluées, présentent différents systèmes d'allumage, **sur demande**: à pleine puissance (version standard) > double allumage > graduable > **en urgency intégré**. Les produits du catalogue sont présentés dans la version avec fonctionnement à tension de réseau de **220-240V AC**. Les produits peuvent aussi être commandés en version **24V DC** pour des installations dans lesquelles la version à basse tension représenterait une solution de conception intéressante. Tous les produits sont conçus pour garantir un flux lumineux élevé, tout en conservant le LED dans les conditions de fonctionnement les meilleures, compte tenu des dimensions des lampes et de la puissance électrique absorbée par la fiche et l'alimentateur. Pour faire tout cela Ailati s'est servie de la collaboration de professionnels du secteur afin de garantir des conceptions de haut niveau et la qualité et durée maximales des produits LED. En particulier, pour les plafonniers, nous avons choisi la conception d'une fiche LED "ad hoc", évitant les solutions commerciales peu adaptées au standard qualitatif exigé par les produits Ailati. Le projet a porté à la conception d'une fiche avec une distribution homogène des LED sur sa surface, pilotable aussi à très basse tension (24VDC). Le choix de la distribution des LED s'est fait tout seul, vu l'homogénéité de l'illumination demandée sur les verres des plafonniers à illuminer, alors que le choix des 24V contient quelques nuances techniques qu'une fiche pilotée au courant ne possède pas : un étage d'entrée en mesure de protéger les LED contre l'imprudente inversion de polarité et les pics de tension sur l'entrée de la fiche ; un balancement du courant d'alimentation sur différentes branches de manière à éviter la mort prématurée de la totalité de la fiche en cas de mauvais fonctionnement d'un LED ; la possibilité d'utiliser la lampe de manière native à 24V dans les applications où la très faible tension est préférable, voire même exigée par la norme. La fiche, en outre, présente deux entrées séparées pour permettre son utilisation avec un double allumage (l'entrée secondaire absorbe une puissance équivalente à ¼ de la primaire) ou utilisant la secondaire pour le fonctionnement de la lampe en urgency. **La fiche LED ainsi conçue a subi une série de vérifications thermiques strictes qui en garantissent la fiabilité pendant au moins trois ans.** En ce qui concerne la véritable source LED, est utilisé le LED qui présente un rapport flux / puissance optimal et un rendement chromatique optimal dans les températures couleur 3000K, et sur demande 2700/4000K.

EL VIDRIO SOPLADO TRIPLEX ENCUENTRA LA FUENTE LUMINOSA LED

La especialidad de Ailati es el vidrio opalino de tres capas. Este tipo de vidrio se diferencia de los normales vidrios soplados opalinos Duplex, por una mayor capacidad de difundir la luz. De hecho, la capa de blanco, puesta entre dos capas de vidrio transparente, es muy fina. De esta forma la reducción de los lúmenes es menor y permite una mayor y más homogénea difusión de la luz. El encuentro de este tipo de difusor con la fuente luminosa LED, es la propuesta específica de Ailati, que permite combinar una óptima calidad del vidrio con una fuente de iluminación tecnológicamente avanzada. La nueva colección de luminarias de techo y luminarias LED del catálogo Ailati incrementa aún más las características técnicas del LED, logrando la perfecta unión entre la mejor fuente luminosa presente en el mercado y el vidrio opalino de altísima calidad y design. La colección deriva de un proyecto de investigación cuyo objetivo es perfeccionar la uniformidad de la iluminación del vidrio opalino y optimizar el flujo luminoso de los LED, sin descuidar la carga térmica máxima permitida en el interior de la luminaria. Estas consideraciones han llevado a la creación de una familia de productos LED: fáciles de instalar > con bajo mantenimiento y larga vida útil > con bajo consumo. Los módulos LED de 25 W, particularmente avanzados, presentan varios sistemas de encendido, **sobre pedido**: plena potencia (versión estándar) > doble encendido > regulable > **de emergencia integrados**. El catálogo contiene los productos en la versión de funcionamiento con voltaje de **220-240 V AC**. Los productos se pueden ordenar, también, en la versión **24V DC** para instalaciones donde la versión de bajo voltaje representa una conveniente solución de diseño. Todos los productos están diseñados para garantizar un alto flujo luminoso, siempre y cuando, los LED sean mantenidos en perfectas condiciones de funcionamiento, teniendo en cuenta las dimensiones de las luminarias y la potencia consumida por el módulo y el alimentador. Ailati, para llevar a cabo este diseño, se ha apoyado en la colaboración de profesionales del sector para garantizar un proyecto de alto nivel con la máxima calidad y duración de los productos LED. De manera especial, para las luminarias de techo, se ha escogido el diseño de un módulo LED "ad hoc", evitando las soluciones comerciales poco adecuadas para los niveles de calidad requeridos para los productos Ailati. El diseño ha llevado a la concepción de un módulo con una distribución uniforme de LED sobre su superficie manejable, también, con bajo voltaje (24 VCD). La elección de la distribución de los LED surgió espontánea para satisfacer la necesidad de una uniforme iluminación de los vidrios de las luminarias de techo, mientras que la elección de los 24V encierra algunos matices técnicos que un módulo conectado a tensión de red no posee: un circuito de entrada capaz de evitar la posibilidad de inversión de la polaridad y picos de tensión; un equilibrio de la corriente de alimentación en los varios sectores de manera tal de evitar la muerte anticipada de todo el módulo en caso de avería de un LED; la posibilidad de utilizar la luminaria con 24V en las aplicaciones donde la baja tensión es preferible o, incluso, lo exigen las normas. El módulo, además, presenta dos entradas separadas para permitir el uso con doble encendido (la entrada secundaria absorbe una potencia igual a ¼ de la primera) o utilizando la secundaria para el funcionamiento de emergencia de la luminaria. **El módulo LED así diseñado ha sido sometido a una serie de rígidos chequeos térmicos que garantizan una fiabilidad de al menos tres años.** Por lo que respecta la propia y verdadera fuente LED se utiliza el LED que presenta una buena relación flujo/potencia y un óptimo rendimiento del color con temperaturas color 3000K, y sobre pedido 2700/4000K.

Sommario *Contents*

Ordine alfabético *Alphabetical order*



Alu
Page 138



Astuccio
Page 110



Berlino
Page 22

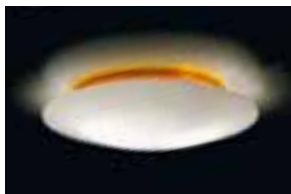

Bis
Page 78



Bis bayonet
Page 82



Box quadrata
Page 96



Box rotonda
Page 94



Bridge
Page 120



Caorle
Page 40



Chiusa
Page 90



Ciclope
Page 134



Cilindro
Page 52



Cip
Page 118



Clara
Page 86



Claretta
Page 106



Cubetto
Page 112



Dado magneto
Page 24



Drum
Page 68



Drum bayonet
Page 74



Drum metal
Page 72



Eclipse quadra
Page 102



Eclipse tonda
Page 98



Lucca
Page 38



Mentos magneto
Page 8



Mine
Page 126



Minidrum
Page 76



Minibis
Page 84



Omega
Page 60



Ovalino
Page 108



Pallina
Page 18



Rialto
Page 28



Riga
Page 130



Sferis
Page 12



Sole
Page 136



Spicchio
Page 92



Stand
Page 32



Stand metal
Page 34



Stick 65
Page 54



Stick 6555
Page 42



Stick 80
Page 44



Stick 100 / 150 / 240
Page 48



Stripe
Page 122



Stripe magneto
Page 123



Treviso
Page 62



Relamping kit
Page 148



Mentos magneto

Parete *Wall*
Soffitto *Ceiling*
Sospensione *Hanging*

Collezione di lampade a sospensione, soffitto e parete in vetro soffiato triplex opale satinato con fonte luminosa a LED. Parti metalliche verniciate bianco opaco. La collezione Mentos ha un particolare sistema di fissaggio vetro a magneti. Questo sistema, oltre a semplificare e velocizzare le installazioni, è molto pratico per le normali manutenzioni.

A collection of hanging, ceiling and wall lamps in satin finish triplex opal blown glass with a LED light source. Matt white painted metal parts. The Mentos collection has a special magnet fixing system for the glass component. In addition to simplifying and speeding up installation operations, this system is highly practical when standard maintenance is required.





Mentos magneto

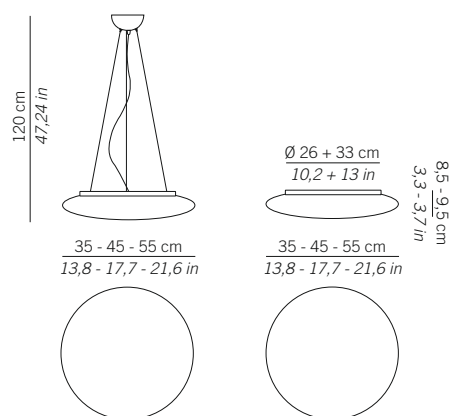

Vetro con attacco a magnete
Glass with magnet attachment

LED		220-240V - 3000K - CRI >80	CE IP20	
	dimensions	code	total absorbtion	lumen Led board
sospensione <i>hanging</i>	∅ 35 cm - ∅ 13,8 in	LD112203B	25W	2117lm
	∅ 45 cm - ∅ 17,7 in	LD113303B	41W	3791lm
	∅ 55 cm - ∅ 21,6 in	LD114403B	41W	3791lm
parete soffitto <i>wall ceiling</i>	∅ 35 cm - ∅ 13,8 in	LD110203B	25W	2117lm
	∅ 45 cm - ∅ 17,7 in	LD110303B	41W	3791lm
	∅ 55 cm - ∅ 21,6 in	LD110403B	41W	3791lm

LED	dimmerabile <i>dimmable</i>	220-240V - 3000K - CRI >80	CE IP20		
	dimensions	code	total absorbtion	lumen Led board	dimmer
sospensione <i>hanging</i>	∅ 35 cm - ∅ 13,8 in	LD112223B	0-25W	0-2117lm	1/10V
	∅ 45 cm - ∅ 17,7 in	LD113323B	0-41W	0-3791lm	1/10V
	∅ 55 cm - ∅ 21,6 in	LD114423B	0-41W	0-3791lm	1/10V
parete soffitto <i>wall ceiling</i>	∅ 35 cm - ∅ 13,8 in	LD110223B	0-25W	0-2117lm	1/10V
	∅ 45 cm - ∅ 17,7 in	LD110323B	0-41W	0-3791lm	1/10V
	∅ 55 cm - ∅ 21,6 in	LD110423B	0-41W	0-3791lm	1/10V



Sferis

Soffitto
Sospensione
Tavolo

*Ceiling
Hanging
Table lamp*

Collezione di lampade a sospensione, soffitto e tavolo in vetro soffiato triplex opale satinato. Parti metalliche cromate o verniciate bianco opaco. Su richiesta IP44.

A collection of hanging, ceiling and table lamps in satin finish triplex opal blown glass. Matt white painted or chrome metal parts. IP44 protection available on request.

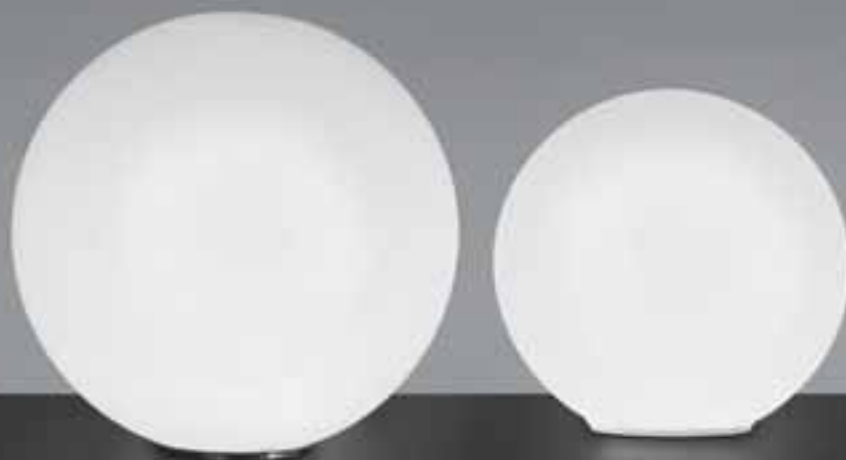







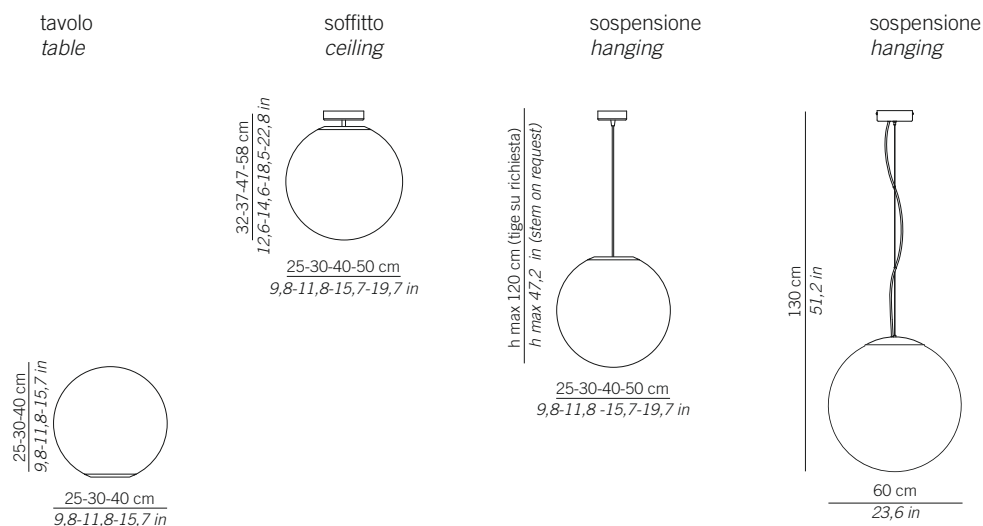

E27		220-240V		CE IP20	
	dimensions	code		lamp connection	Watt max
		cromo chrome	bianco white		
sospensione hanging	ø 25 cm - ø 9,8 in	LL4103...	LL4103B...	E27	1x52HS
	ø 30 cm - ø 11,8 in	LL4100...	LL4100B...	E27	1x70HS
	ø 40 cm - ø 15,7 in	LL4101...	LL4101B...	E27	1x70HS
	ø 50 cm - ø 19,7 in	LL4111...	LL4111B...	E27	1x105HS
	ø 60 cm - ø 23,6 in	LL4112	LL4012B	E27	2x52HS
soffitto ceiling	ø 25 cm - ø 9,8 in	LL4203...	LL4203B...	E27	1x52HS
	ø 30 cm - ø 11,8 in	LL4200...	LL4200B...	E27	1x70HS
	ø 40 cm - ø 15,7 in	LL4201...	LL4201B...	E27	1x70HS
	ø 50 cm - ø 19,7 in	LL4210...	LL4210B...	E27	1x105HS
tavolo table lamp	ø 25 cm - ø 9,8 in	not available	LL4303B	E27	1x52HS
	ø 30 cm - ø 11,8 in	not available	LL4300B	E27	1x70HS
	ø 40 cm - ø 15,7 in	no available	LL4301B	E27	1x70HS

canopy	dimensions	available on
	ø 8 h 2,5 cm - 3,1 h 1,0 in	E27 ø 25 / 30 cm
	ø 10 h 2,5 cm - 3,9 h 1,0 in	E27 ø 40 / 50 / 60 cm
	ø 11 h 4,5 cm - 4,3 h 1,8 in	E27 ø 25 / 30 / 40 / 50 cm IP44

...IP44 su richiesta - on request



Pallina

Parete
Soffitto

Wall
Ceiling



Pallina

Parete
Soffitto

Wall
Ceiling

Collezione di lampade in vetro soffiato triplex opale satinato con fonte luminosa a LED. E' disponibile nelle due versioni, da incasso con alimentatore in remoto e da superficie con alimentatore nella base, entrambe a parete e soffitto. Parti metalliche cromate.

A collection of lamps in satin finish triplex opal blown glass with a LED light source. Available in two versions: recessed with a remote power adaptor or surface-mounted with a power adaptor in the base. Both versions are available in a wall and ceiling version. Chrome metal parts.



Versione da incasso con alimentatore in remoto.
Version with recessed remote power adaptor.

Versione con alimentatore nella base.
Version with power adaptor in the base.

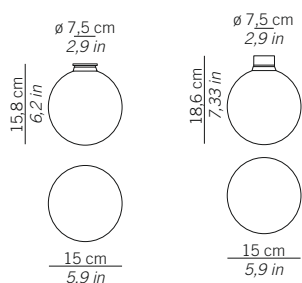

LED		220-240V - 3000K - CRI >80	CE IP20
	dimensions	code _____ cromo chrome	total absorbtion lumen Led board
incasso parete soffitto recessed wall ceiling	Ø 15 cm - Ø 5,9 in	LD9916C3...	8W 700lm

...IP44 su richiesta - on request

LED		220-240V - 3000K - CRI >80	CE IP20
	dimensions	code _____ cromo chrome	total absorbtion lumen Led board
plafone parete soffitto wall and ceiling-mounted lamp	Ø 15 cm - Ø 5,9 in	LD9917C3	4W 320lm

Pallina

Collezione di lampade a sospensione, parete e tavolo in vetro soffiato triplex opale satinato. Parti metalliche cromate.

A collection of hanging, wall and table lamps in satin finish triplex opal blown glass. Chrome metal parts.

Parete
Tavolo
Sospensione

Wall
Table
Hanging



parete
wall

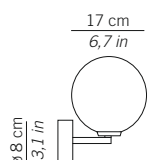

tavolo
table

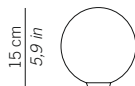

sospensione
hanging

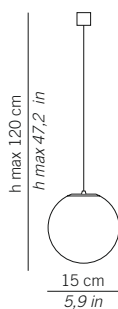

HALO		220-240V	CE IP20	
	dimensions	code	lamp connection	Watt max
		cromo		
		chrome		
tavolo table lamp	∅ 15 cm - ∅ 5,9 in	LL9912	G9	1x33HS □
sospensione hanging	∅ 15 cm - ∅ 5,9 in	LL9913	G9	1x33HS
parete wall	∅ 17 cm - ∅ 6,7 in	LL9914	G9	1x33HS

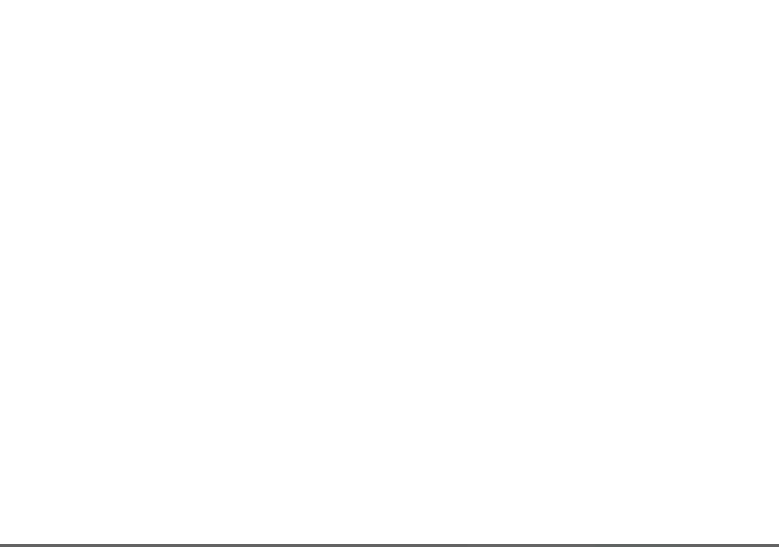

Berlino

Parete
Soffitto
Tavolo

Wall
Ceiling
Table lamp

Collezione di lampade da tavolo, parete e soffitto in vetro soffiato triplex opale satinato. Parti metalliche cromate o verniciate bianco opaco.

A collection of table, wall and ceiling lamps in satin finish triplex opal blown glass. Matt white painted or chrome metal parts.

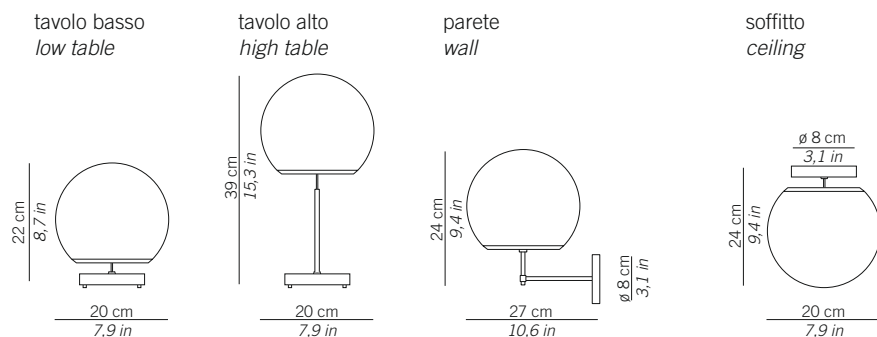

E27		220-240V	CE IP20		
	dimensions	code	lamp connection	Watt max	
tavolo basso low table	h 22 cm - h 8,7 in	LL4302	E27	1x42HS □	
tavolo alto high table	h 39 cm - h 15,3 in	LL4402	E27	1x42HS □	
soffitto ceiling	h 24 cm - h 9,4 in	LL4202	E27	1x42HS	
parete wall	h 24 cm - h 9,4 in	LL4502	E27	1x42HS	

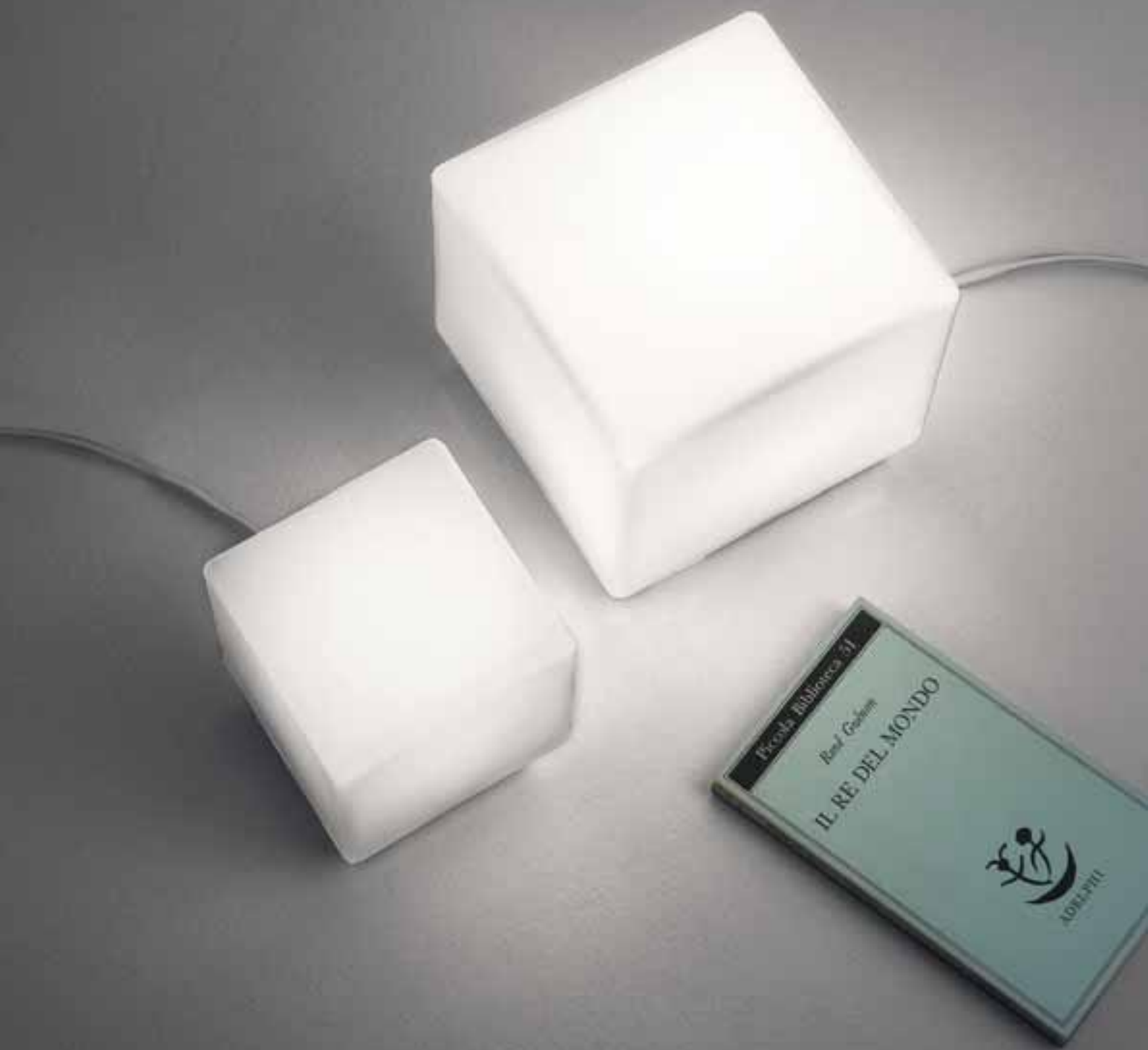

Dado magneto

Collezione di lampade a sospensione, soffitto, tavolo e parete in vetro soffiato triplex opale satinato. Parti metalliche disponibili nelle finiture cromo, nichel satinato o verniciato bianco opaco. La collezione Dado ha un particolare sistema di fissaggio vetro a magneti. Questo sistema, oltre a semplificare e velocizzare le installazioni, è molto pratico per le normali manutenzioni.

A collection of hanging, ceiling, table and wall lamps in satin finish triplex opal blown glass. Metal parts are available in the following finishes: chrome, satin nickel or matt white painted. The Dado collection has a special magnet fixing system for the glass component. In addition to simplifying and speeding up installation operations, this system is highly practical when standard maintenance is required.

Parete
Soffitto
Sospensione
Tavolo

Wall
Ceiling
Hanging
Table





Dado magneto

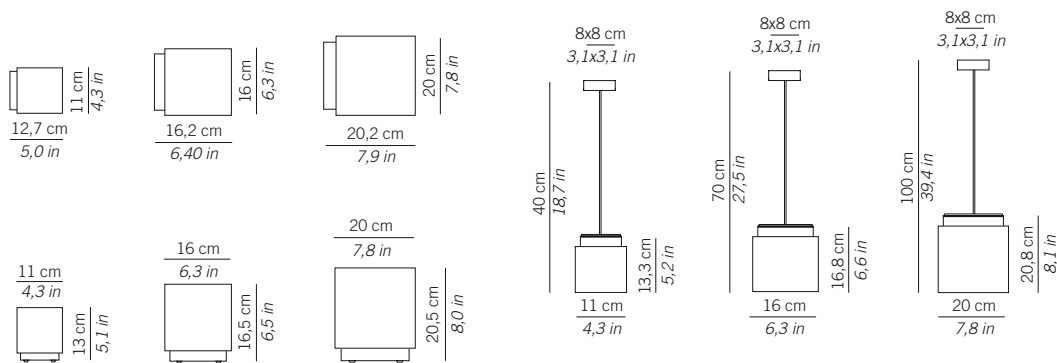

Vetro con attacco a magnete
Glass with magnet attachment

E27		220-240V			CE IP40	
	dimensions	code			lamp connection	Watt max
		cromo chrome	bianco white	nicel spazzolato brushed nickel		
parete soffitto wall ceiling	11x11 cm - 4,3x4,3 in	LL2004C	LL2004B	LL2004NS	E27 small bulb	1x28HS
	16x16 cm - 6,3x6,3 in	LL2002C	LL2002B	LL2002NS	E27	1x28HS
soffitto ceiling	20x20 cm - 7,8x7,8 in	LL2003C	LL2003B	LL2003NS	E27	2x28HS
tavolo bassa low table	11x11 cm - 4,3x4,3 in	LL2024C	LL2024B	LL2024NS	E27 small bulb	1x28HS
	16x16 cm - 6,3x6,3 in	LL2022C	LL2022B	LL2022NS	E27	1x28HS
	20x20 cm - 7,8x7,8 in	LL2023C	LL2023B	LL2023NS	E27	2x28HS
sospensione hanging	11x11 cm - 4,3x4,3 in	LL2014CH040	LL2014BH040	LL2014NSH040	E27 small bulb	1x28HS
	11x11 cm - 4,3x4,3 in	LL2014CH070	LL2014BH070	LL2014NSH070	E27 small bulb	1x28HS
	11x11 cm - 4,3x4,3 in	LL2014CH100	LL2014BH100	LL2014NSH100	E27 small bulb	1x28HS
	16x16 cm - 6,3x6,3 in	LL2012CH040	LL2012BH040	LL2012NSH040	E27	1x28HS
	16x16 cm - 6,3x6,3 in	LL2012CH070	LL2012BH070	LL2012NSH070	E27	1x28HS
	16x16 cm - 6,3x6,3 in	LL2012CH100	LL2012BH100	LL2012NSH100	E27	1x28HS
	20x20 cm - 7,8x7,8 in	LL2013CH040	LL2013BH040	LL2013NSH040	E27	2x28HS
	20x20 cm - 7,8x7,8 in	LL2013CH070	LL2013BH070	LL2013NSH070	E27	2x28HS
	20x20 cm - 7,8x7,8 in	LL2013CH100	LL2013BH100	LL2013NSH100	E27	2x28HS

LED		220-240V - CRI >80			CE IP40		
	dimensions	code			total absorption	colour temperature	lumen Led board
		cromo chrome	bianco white	nicel spazzolato brushed nickel			
parete soffitto wall ceiling	11x11 cm - 4,3x4,3 in	LD2004C	LD2004B	LD2004NS	4W	2900K	420lm
	16x16 cm - 6,3x6,3 in	LD2002C	LD2002B	LD2002NS	8W	2900K	750lm
soffitto ceiling	20x20 cm - 7,8x7,8 in	LD2003C	LD2003B	LD2003NS	13W	3000K	911lm
tavolo bassa low table	11x11 cm - 4,3x4,3 in	LD2024C	LD2024B	LD2024NS	4W	2900K	420lm
	16x16 cm - 6,3x6,3 in	LD2022C	LD2022B	LD2022NS	8W	2900K	750lm
	20x20 cm - 7,8x7,8 in	LD2023C	LD2023B	LD2023NS	13W	3000K	911lm
sospensione hanging	11x11 cm - 4,3x4,3 in	LD2014CH040	LD2014BH040	LD2014NSH040	4W	2900K	420lm
	11x11 cm - 4,3x4,3 in	LD2014CH070	LD2014BH070	LD2014NSH070	4W	2900K	420lm
	11x11 cm - 4,3x4,3 in	LD2014CH100	LD2014BH100	LD2014NSH100	4W	2900K	420lm
	16x16 cm - 6,3x6,3 in	LD2012CH040	LD2012BH040	LD2012NSH040	8W	2900K	750lm
	16x16 cm - 6,3x6,3 in	LD2012CH070	LD2012BH070	LD2012NSH070	8W	2900K	750lm
	16x16 cm - 6,3x6,3 in	LD2012CH100	LD2012BH100	LD2012NSH100	8W	2900K	750lm
	20x20 cm - 7,8x7,8 in	LD2013CH040	LD2013BH040	LD2013NSH040	13W	3000K	911lm
	20x20 cm - 7,8x7,8 in	LD2013CH070	LD2013BH070	LD2013NSH070	13W	3000K	911lm
	20x20 cm - 7,8x7,8 in	LD2013CH100	LD2013BH100	LD2013NSH100	13W	3000K	911lm

Rialto

Parete
Soffitto

Wall
Ceiling

Collezione di lampade da parete e soffitto in vetro soffiato triplex opale satinato. Parti metalliche verniciate bianco opaco.

A collection of wall and ceiling lamps in satin finish triplex opal blown glass. Matt white painted metal parts.





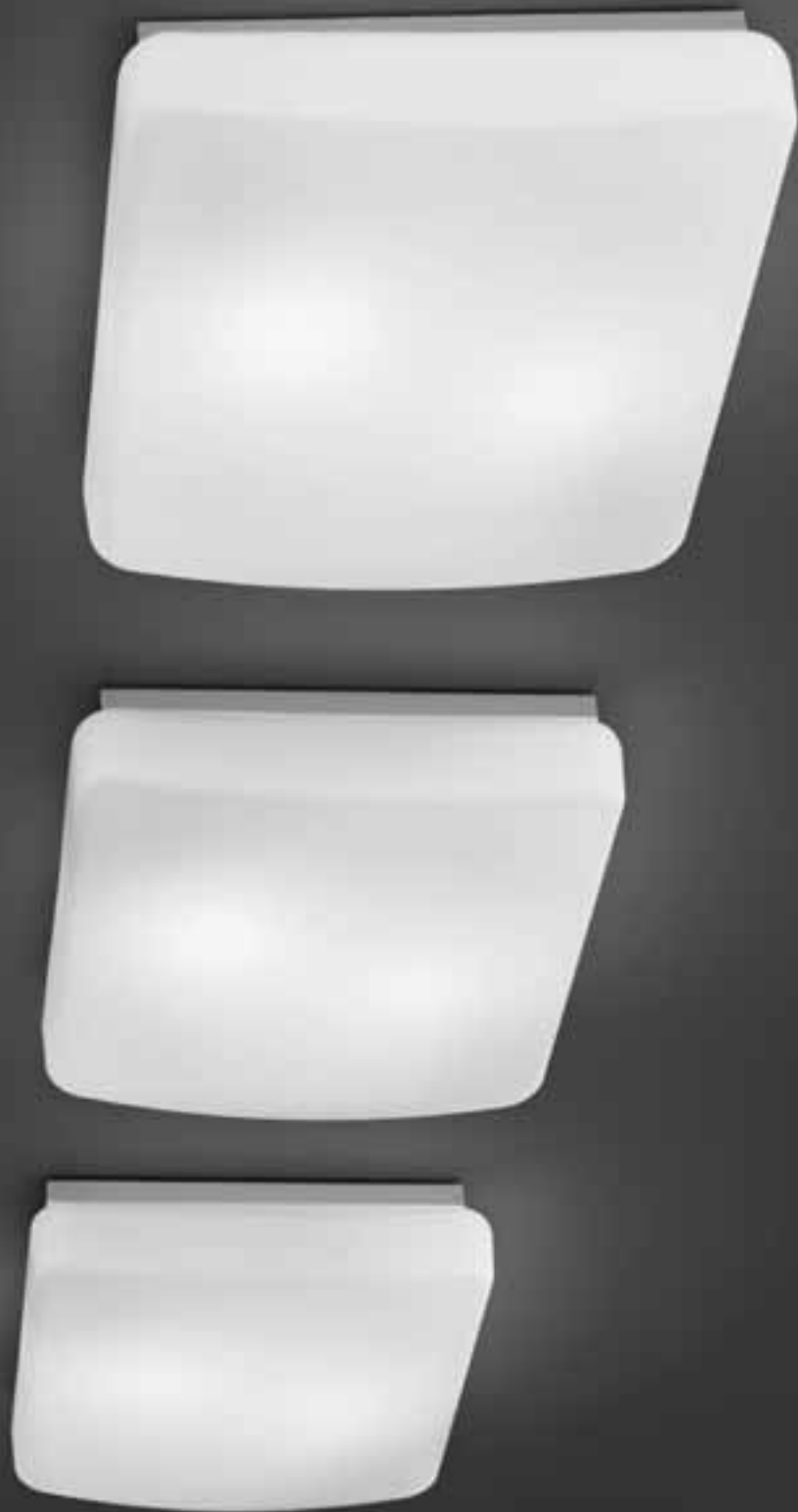

Rialto

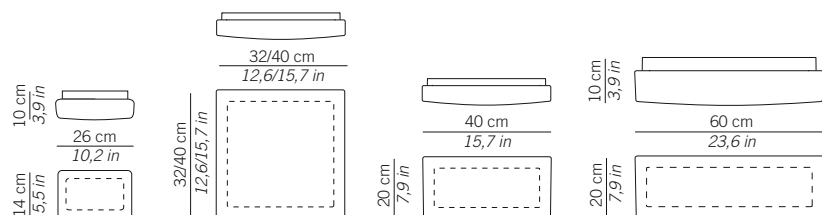

E27		220-240V - 3000K - CRI >80 C E IP40		
	dimensions	code	lamp connection	Watt max
parete soffitto wall ceiling	14x26 cm - 5,5x10,2 in	LL3060	E27	1x70HS
	20x40 cm - 7,9x15,7 in	LL3040	E27	2x52HS
	32x32 cm - 12,6x12,6 in	LL3020	E27	2x52HS
	40x40 cm - 15,7x15,7 in	LL3030	E27	2x70HS
	20x60 cm - 7,9x23,6 in	LL3070	E27	3x52HS

FLUO		220-240V - 3000K - CRI >80 C E IP40		
	dimensions	code	lamp connection	Watt max
parete soffitto wall ceiling	14x26 cm - 5,5x10,2 in	LL3061	G24q-3	1x26
	20x40 cm - 7,9x15,7 in	LL3041	2G11	2x24
	32x32 cm - 12,6x12,6 in	LL3021	2G10	2x24
	40x40 cm - 15,7x15,7 in	LL3031	2G10	2x36
	20x60 cm - 7,9x23,6 in	LL3071	2G11	2x36

LED		220-240V - 3000K - CRI >80 C E IP40		
	dimensions	code	total absorption	lumen Led board
parete soffitto wall ceiling	32x32 cm - 12,6x12,6 in	LD302003	25W	2117lm
	40x40 cm - 15,7x15,7 in	LD303003	41W	3791lm

LED dimmerabile dimnable		220-240V - 3000K - CRI >80 C E IP40			
	dimensions	code	total absorption	lumen Led board	dimmer
parete soffitto wall ceiling	32x32 cm - 12,6x12,6 in	LD302203	0-25W	0-2117lm	1/10V
	40x40 cm - 15,7x15,7 in	LD303203	0-41W	0-3791lm	1/10V

LED emergenza emergency		220-240V - 3000K - CRI >80 C E IP40		
	dimensions	code	total absorption	lumen Led board
parete soffitto wall ceiling	32x32 cm - 12,6x12,6 in	LD309203	6-25W	470-2117lm
	40x40 cm - 15,7x15,7 in	LD309103	12-41W	760-3791lm

Emergenza Versione con dispositivo di emergenza per l'alimentazione in luce permanente di una lampada. Autonomia 1h.
Emergency Version with emergency device for powering one permanent lamp. Autonomy 1 hour.



Stand

Parete
Soffitto

Wall
Ceiling

Collezione di lampade a parete e soffitto in vetro soffiato triplex opale satinato. Parti metalliche verniciate bianco opaco. Su richiesta IP44.

A collection of wall and ceiling lamps in satin finish triplex opal blown glass. Matt white painted metal parts. IP44 protection available on request.

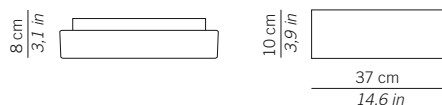

E27		220-240V	CE IP40	
	dimensions	code	lamp connection	Watt max
parete soffitto wall ceiling	37x10 cm - 14,6x3,9 in	LL3001...	E27	2x28 HSGS
FLUO		220-240V	CE IP40	
	dimensions	code	lamp connection	Watt max
parete soffitto wall ceiling	37x10 cm - 14,6x3,9 in	LL3002...	2G11	1x24
LED		220-240V - 3200K - CRI >80	CE IP40	
	dimensions	code	total absorbtion	lumen Led board
parete soffitto wall ceiling	37x10 cm - 14,6x3,9 in	LD300103...	9W	680lm

...IP44 su richiesta - on request



Stand metal

Parete
Soffitto

Wall
Ceiling

Collezione di lampade a parete e soffitto in vetro soffiato triplex opale satinato. Parti metalliche cromate o verniciate bianco opaco.

A collection of wall and ceiling lamps in satin finish triplex opal blown glass. Matt white painted or chrome metal parts.

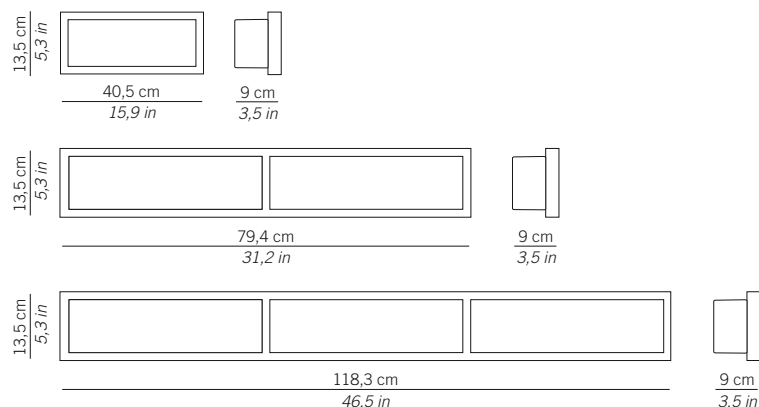

E27		220-240V	C€ IP40				
		dimensions		code		lamp connection	Watt max
parete soffitto wall ceiling	1 vetro 1 glass component	40,5x13,5 cm - 15,9x5,3 in		cromo chrome	bianco white	E27	2x28 HSGS
				LL3001C...	LL3001B...		

FLUO		220-240V	C€ IP40				
		dimensions		code		lamp connection	Watt max
parete soffitto wall ceiling	1 vetro 1 glass component	40,5x13,5 cm - 15,9x5,3 in		cromo chrome	bianco white	2G11	1x24
				LL3002C...	LL3002B...		

LED		3200K - CRI >80	C€ IP40				
		dimensions		code		total absorbtion	lumen Led board
parete soffitto wall ceiling	1 vetro 1 glass component	39x12 cm - 15,35x4,72 in		cromo chrome	bianco white	9W	680lm
				LD3001C3...	LD3001B3...		

...IP44 su richiesta - on request

E27		220-240V	C€ IP40				
		dimensions		code		lamp connection	Watt max
parete soffitto wall ceiling	2 vetri 2 glass components	79,4x13,5x9 cm - 31,2x5,3x3,5 in		cromo chrome	bianco white	E27	4x28 HSGS
	3 vetri 3 glass components	118,3x13,5x9 cm - 46,5x5,3x3,5 in		LL3003C	LL3003B	E27	6x28 HSGS
				LL3004C	LL3004B		

FLUO		220-240V	C€ IP40				
		dimensions		code		lamp connection	Watt max
parete soffitto wall ceiling	2 vetri 2 glass components	79,4x13,5x9 cm - 31,2x5,3x3,5 in		cromo chrome	bianco white	2G11	2x24
	3 vetri 3 glass components	118,3x13,5x9 cm - 46,5x5,3x3,5 in		LL3005C	LL3005B	2G11	3x24
				LL3006C	LL3006B		

LED		220-240V - 3200K - CRI >80	C€ IP40				
		dimensions		code		total absorbtion	lumen Led board
parete soffitto wall ceiling	2 vetri 2 glass components	79,4x13,5x9 cm - 31,2x5,3x3,5 in		cromo chrome	bianco white	2x9W	2x680lm
	3 vetri 3 glass components	118,3x13,5x9 cm - 46,5x5,3x3,5 in		LD3003C	LD3003B	3x9W	3x680lm
				LD3004C	LD3004B		

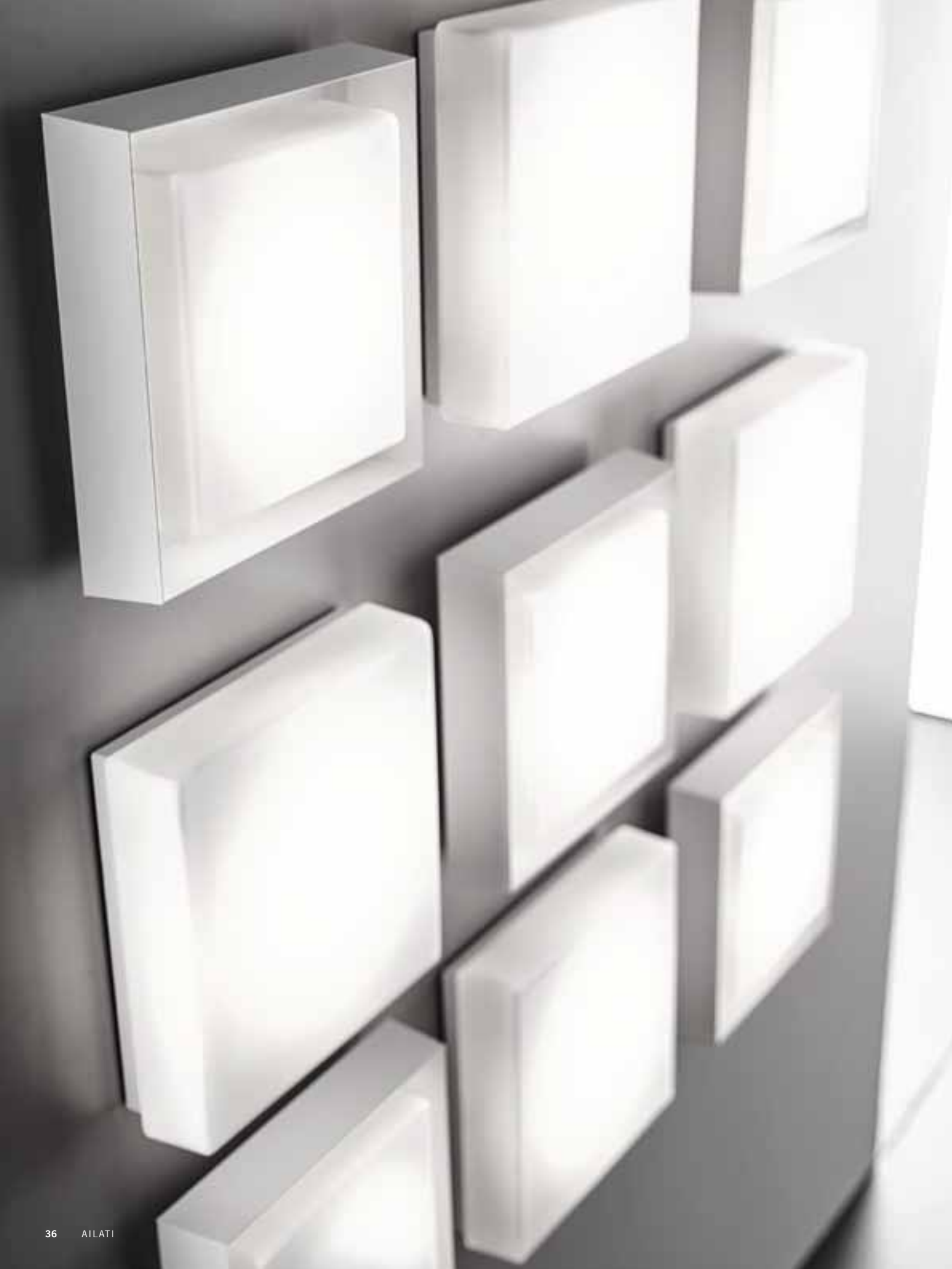

Lucca / Caorle





Collezione di lampade a parete e soffitto in vetro soffiato triplex opale satinato. Parti metalliche disponibili nelle finiture verniciato bianco opaco, nero opaco e grigio opaco. La collezione Lucca è personalizzabile con colori a richiesta.

A collection of wall and ceiling lamps in satin finish triplex opal blown glass. Metal parts are available in the following finishes: matt white painted, matt black and matt grey. The Lucca collection can be customised in colours on request.

Colori
Colours



RAL 9003
Bianco opaco
Matt white



RAL 9005
Nero opaco
Matt black



RAL 7047
Grigio opaco
Matt grey

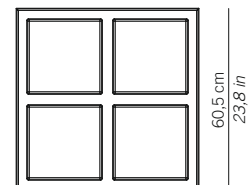
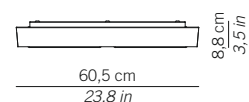
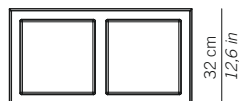
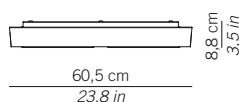
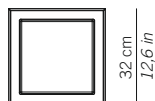
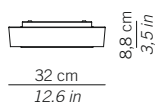

E27		220-240V		C€ IP20		
	dimensions	code			lamp connection	Watt max
		bianco white	Bicolore bianco+nero Two-tone white+black	Bicolore bianco+grigio Two-tone white+grey		
parete soffitto wall ceiling	32x32 cm - 12,6x12,6 in	LL1303B	LL1303N	LL1303G	2xE27	2x42HS
	32x60,5 cm - 12,6x23,8 in	LL1302B	LL1302N	LL1302G	4xE27	4x42HS
	60,5x60,5 cm - 23,8x23,8 in	LL1301B	LL1301N	LL1301G	8xE27	8x42HS

LED		220-240V - 3000K - CRI >80		C€ IP20		
	dimensions	code			total absorbtion	lumen Led board
		bianco white	Bicolore bianco+nero Two-tone white+black	Bicolore bianco+grigio Two-tone white+grey		
parete soffitto wall ceiling	32x32 cm - 12,6x12,6 in	LD1303B3	LD1303N3	LD1303G3	1x16W	1x1502lm
	32x60,5 cm - 12,6x23,8 in	LD1302B3	LD1302N3	LD1302G3	2x16W	2x1502lm
	60,5x60,5 cm - 23,8x23,8 in	LD1301B3	LD1301N3	LD1301G3	4x16W	4x1502lm



Caorle

Parete
Soffitto

Wall
Ceiling

Collezione di lampade a parete e soffitto in vetro soffiato triplex opale satinato. Parti metalliche verniciate bianco opaco.

A collection of wall and ceiling lamps in satin finish triplex opal blown glass. Matt white painted metal parts.

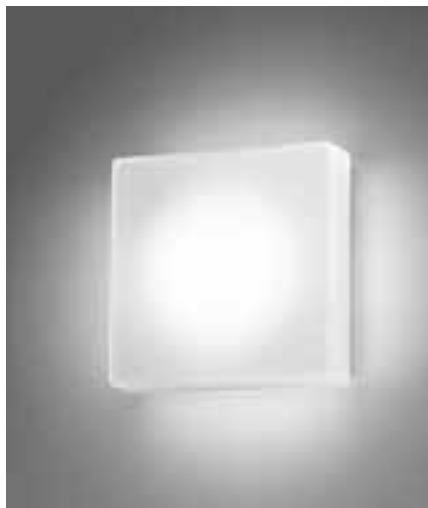
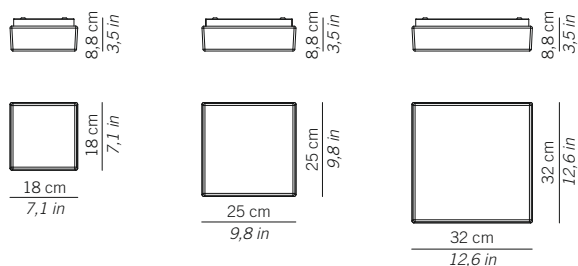

E27		220-240V	CE IP20
	dimensions	code	lamp connection Watt max
parete soffitto	18x18 cm - 7,1x7,1 in	LL1304	E27 1x28HS
wall ceiling	25x25 cm - 9,8x9,8 in	LL1305	E27 2x28HS
	32x32 cm - 12,6x12,6 in	LL1306	E27 3x28HS

LED		220-240V - 3000K - CRI >80	CE IP20
	dimensions	code	total absorption lumen Led board
parete soffitto	18x18 cm - 7,1x7,1 in	LD130403	13W 911lm
wall ceiling	25x25 cm - 9,8x9,8 in	LD130503	16W 1502lm
	32x32 cm - 12,6x12,6 in	LD130603	25W 2117lm

LED dimmerabile <i>dimnable</i>		220-240V - 3000K - CRI >80	CE IP20
	dimensions	code	total absorption lumen Led board dimmer
parete soffitto	25x25 cm - 9,8x9,8 in	LD132503	0-16W 0-1502lm 1/10V
wall ceiling	32x32 cm - 12,6x12,6 in	LD132603	0-25W 0-2117lm 1/10V

LED emergenza <i>emergency</i>		220-240V - 3000K - CRI >80	CE IP20
	dimensions	code	total absorption lumen Led board
parete soffitto	32x32 cm - 12,6x12,6 in	LD133603	6-25W 470lm-2117lm
wall ceiling			

LED 2700K / 4000K su richiesta - *on request*



Stick 6555

Parete

Wall

Collezione di lampade a parete in vetro soffiato triplex opale satinato e fonte luminosa a LED. Parti metalliche verniciate bianco opaco.

A collection of wall lamps in satin finish triplex opal blown glass, with a LED light source. Matt white painted metal parts.

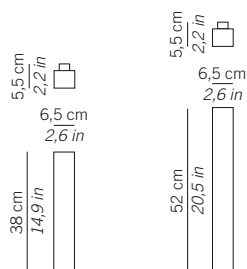
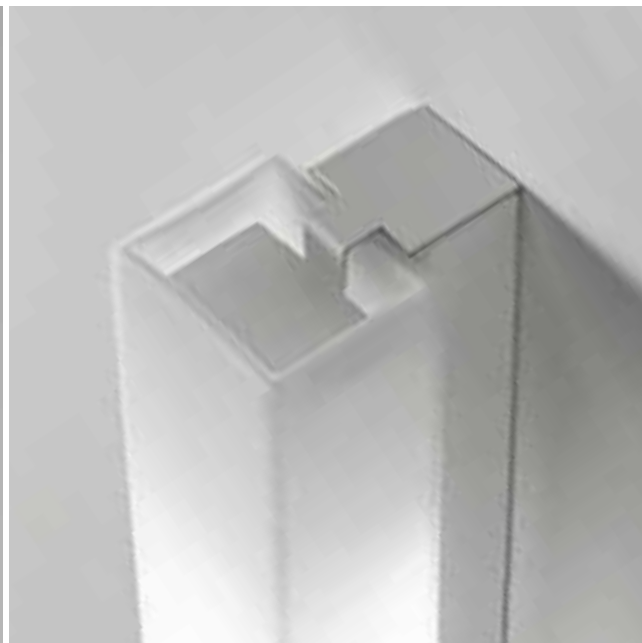

LED	220-240V - 3000K - CRI >80		CE IP20		
	dimensions	code	power Led	total absorption	lumen lamp
parete wall	6,5x38x5,5 cm - 2,6x14,9x2,2 in	LD6501B3	12W	15,2W	1485lm
parete wall	6,5x52x5,5 cm - 2,6x20,5x2,2 in	LD6502B3	14W	16,3W	1529lm

Posizionamento sia verticale sia orizzontale. Con placca di chiusura per i lati aperti - *Vertical or horizontal. End plate for closing open sides.*



Stick 80

Parete

Wall

Collezione di lampade a parete in vetro soffiato triplex opale lucido e fonte luminosa a LED. Parti metalliche verniciate bianco opaco.

*A collection of wall lamps in gloss triplex opal blown glass, with a LED light source.
Matt white painted metal parts.*





Stick 80

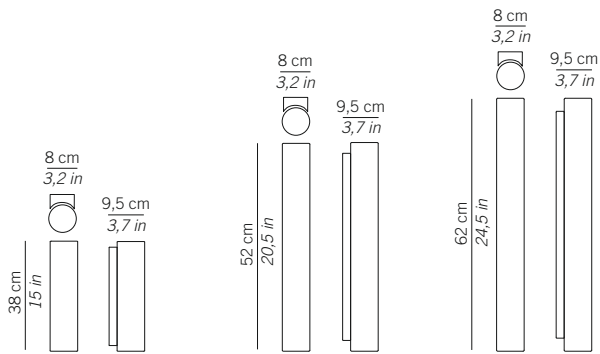

LED	220-240V - 3000K - CRI >80		CE IP20		
	dimensions	code	power Led	total absorbtion	lumen lamp
parete wall	8x38x9,5 cm - 3,2x15x3,7 in	LD9591B3	12W	15,2W	1485lm
parete wall	8x52x9,5 cm - 3,2x20,5x3,7 in	LD9592B3	15W	16,3W	1529lm
parete wall	8x62x9,5 cm - 3,2x24,5x3,7 in	LD9593B3	22W	27,5W	2462lm

Posizionamento sia verticale sia orizzontale. Con placca di chiusura per i lati aperti. **Vetro lucido.**
 Vertical or horizontal. End plate for closing open sides. **Glossy glass.**



Stick 100 / 150 / 240

Sospensione *Hanging*

Collezione di lampade a sospensione cilindriche in vetro soffiato triplex opale satinato. Parti metalliche cromate o verniciate bianco opaco. Su richiesta fuori misura e apparecchi speciali.

A collection of hanging cylinder lamps in satin finish triplex opal blown glass. Matt white painted or chrome metal parts. Special sizes and appliances are available on request.





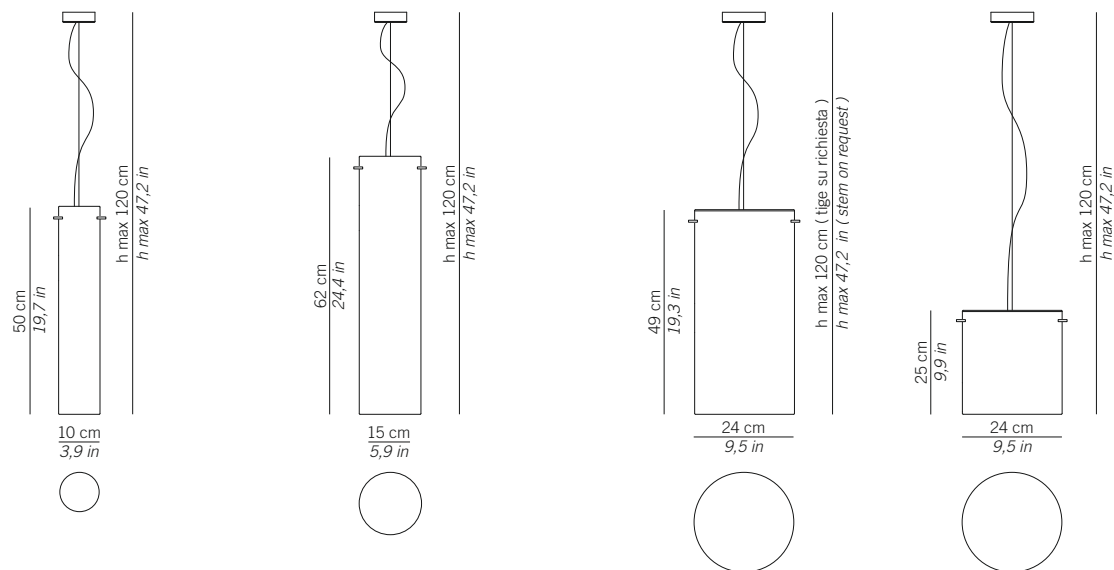

Stick 100 / 150 / 240

Sospensione - Vetro aperto a fascio libero
Hanging - Open glass system



E27	220-240V		C€ IP20	
	dimensions	code	lamp connection	Watt max
sospensione vetro aperto hanging open glass	∅ 10 h 50 cm - ∅ 3,9 h 19,7 in	LL9610	E27	1x70HS
	∅ 15 h 62 cm - ∅ 5,9 h 24,4 in	LL9710	E27	1x70HS
sospensione grande large hanging	∅ 24 h 49 cm - ∅ 9,5 h 19,3 in	LL9821	E27	1x70HS
sospensione piccola small hanging	∅ 24 h 25 cm - ∅ 9,5 h 9,9 in	LL9827	E27	1x52HS

canopy	dimensions	available on
	∅ 8 h 2,5 cm - ∅ 3,1 h 1,0 in	Stick 100 / 150
	∅ 10 h 2,5 cm - ∅ 3,9 h 1,0 in	Stick 240



Cilindro

Collezione di lampade a sospensione e soffitto in vetro soffiato triplex opale satinato. Parti metalliche cromate o verniciate bianco opaco.

A collection of hanging and ceiling lamps in satin finish triplex opal blown glass. Matt white painted or chrome metal parts.

Soffitto
Sospensione

Ceiling
Hanging

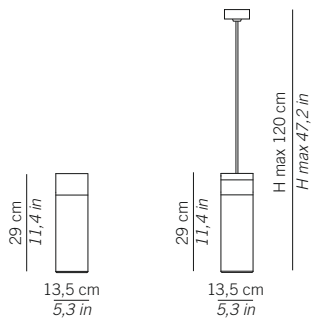

E27	dimensions	220-240V		IP	lamp connection	Watt max
		code cromo chrome	code bianco white			
soffitto <i>ceiling</i>	∅ 13,5x29 cm - ∅ 5,3x11,4 in	LL9250	LL9250B	IP40	E27	1x70HS
	∅ 13,5x29 cm - ∅ 5,3x11,4 in	LL9252	LL9252B	IP44	E27	1x70HS
sospensione <i>hanging</i>	∅ 13,5x29 cm - ∅ 5,3x11,4 in	LL9255	LL9255B	IP40	E27	1x70HS



Stick 65

Parete singola Single wall

Collezione di lampade a sospensione e parete caratterizzate da una serie di cilindri in vetro soffiato opale triplex satinato, chiusi alle estremità per un effetto "tutta luce" ed una luminescenza ottimale. Parti metalliche cromate. L'applicazione di un innovativo sistema a vite applicato al vetro permette una facile installazione e manutenzione. La collezione Stick 65 ha un grado di protezione IP40 o IP44.

A collection of hanging and wall lamps featuring a set of cylinders in satin finish triplex opal blown glass, closed at the ends for an "all light" effect and optimum luminescence. Chrome metal parts. The application of an innovative screw system allows easy installation and maintenance. The Stick 65 collection has IP40 or IP44 protection.

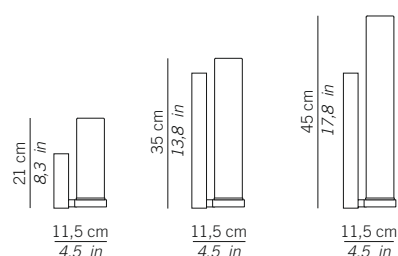

E27	220-240V	C € IP44	
dimensions	code	lamp connection	Watt max
	cromo		
	chrome		
parete wall	h 21 cm - h 8,3 in	LL9511	E27 1x42HS

FLUO	220-240V	C € IP44	
dimensions	code	lamp connection	Watt max
	cromo		
	chrome		
parete wall	h 21 cm - h 8,3 in	LL9513	G24q-3 1x26
	h 35 cm - h 13,8 in	LL9515	2G11 1x24
	h 45 cm - h 17,8 in	LL9517	2G11 1x36

LED	3000K - CRI >80	C € IP44				
dimensions	code	power Led	total absorbtion	lumen lamp		
parete wall	h 21 cm - h 8,3 in	LD9511C3	6,7W	9,6W	623lm	100-240V
	h 35 cm - h 13,8 in	LD9515C3	10W	15,7W	1063lm	220-240V
	h 45 cm - h 17,8 in	LD9517C3	13,4W	19W	1127lm	220-240V





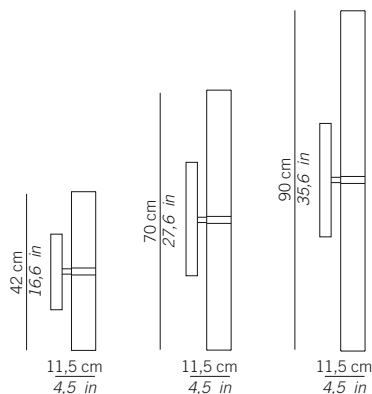

E27	220-240V	CE IP44	
dimensions	code	lamp connection	Watt max
	cromo		
	chrome		
parete wall	L 42 cm - L 16,6 in	LL9521	E27 2x42HS

FLUO	220-240V	CE IP44	
dimensions	code	lamp connection	Watt max
	cromo		
	chrome		
parete wall	L 42 cm - L 16,6 in	LL9523	G24q-3 2x26
	L 70 cm - L 27,6 in	LL9525	2G11 2x24
	L 90 cm - L 35,6 in	LL9527	2G11 2x36



LED	3000K - CRI >80	CE IP44			
dimensions	code	power Led	total absorbtion	lumen lamp	
parete wall	h 42 cm - h 16,6 in	LD9521C3	2x6,7W	2x9,6W	2x623lm 100-240V
	h 70 cm - h 27,6 in	LD9525C3	2x10W	2x15,7W	2x1063lm 220-240V
	h 90 cm - h 35,6 in	LD9527C3	2x13,4W	2x19W	2x1127lm 220-240V



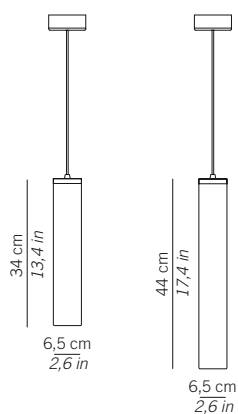



E27		220-240V	CE IP40	
	dimensions	code	lamp connection	Watt max
		chromo		
		chrome		
soffitto <i>ceiling</i>	h 20 cm - h 7,9 in	LL9540...	E27	1x42HS
FLUO		220-240V	CE IP40	
	dimensions	code	lamp connection	Watt max
		chromo		
		chrome		
soffitto <i>ceiling</i>	h 20 cm - h 7,9 in	LL9542...	G24q-3	1x26
sospensione verticale	h 34 cm - h 13,4 in	LL9544...	2G11	1x24
<i>vertical hanging</i>	h 44 cm - h 17,4 in	LL9546...	2G11	1x36

canopy	dimensions	available on
	∅ 13,5 h 5,0 cm - ∅ 5,3 h 1,9 in	1x36W
	∅ 11 h 4,5 cm - ∅ 4,3 h 1,8 in	1x24 / 26W E27 IP44
	∅ 8 h 2,5 cm - ∅ 3,1 h 1,0 in	E27 IP40



Omega

Parete
Soffitto

Wall
Ceiling

Collezione di lampade a parete e soffitto in vetro soffiato triplex opale satinato. Parti metalliche cromate. La collezione Omega ha un grado di protezione IP44, idonea per bagni e sopra specchi.

A collection of wall and ceiling lamps in satin finish triplex opal blown glass. Chrome metal parts. The Omega collection has IP44 protection, making it ideal for bathrooms and installation above mirrors.

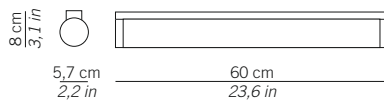

LED		220-240V - 3000K - CRI >80	CE IP44		
	dimensions	code	power Led	total absorbtion	lumen lamp
parete soffitto wall ceiling	8x60x5,7 cm - 3,1x23,6x2,2 in	LD9566C3	18W	20W	2362lm





Parete
Soffitto
Sospensione

Wall
Ceiling
Hanging

Treviso

Collezione di lampade a sospensione, soffitto e parete in vetro soffiato triplex opale satinato. Parti metalliche disponibili nelle finiture verniciato bianco opaco, nero opaco e grigio opaco. La collezione Treviso è personalizzabile con colori a richiesta.

A collection of hanging, ceiling and wall lamps in satin finish triplex opal blown glass. Metal parts are available in the following finishes: matt white painted, matt black and matt grey. The Treviso collection can be customised in colours on request.



Treviso

Sospensione *Hanging*

Colori
Colours



RAL 9003
Bianco opaco
Matt white



RAL 9005
Nero opaco
Matt black



RAL 7047
Grigio opaco
Matt grey

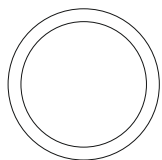
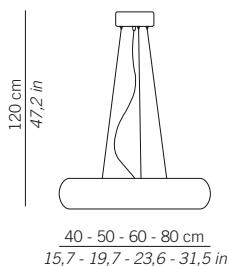

E27		220-240V	C€ IP20			
	dimensions	code			lamp connection	Watt max
		bianco white	bianco / nero white / black	bianco / grigio white / grey		
sospensione <i>hanging</i>	∅ 40 cm - ∅ 15,7 in	LL121103B	LL121103N	LL121103G	E27	1x42HS
	∅ 50 cm - ∅ 19,7 in	LL121203B	LL121203N	LL121103G	E27	2x42HS
	∅ 60 cm - ∅ 23,6 in	LL121303B	LL121303N	LL121103G	E27	3x42HS
	∅ 80 cm - ∅ 31,5 in	LL121403B	LL121403N	LL121103G	E27	5x52HS

FLUO		220-240V	C€ IP20			
	dimensions	code			lamp connection	Watt max
		bianco white	bianco / nero white / black	bianco / grigio white / grey		
sospensione <i>hanging</i>	∅ 40 cm - ∅ 15,7 in	LL12801B	LL12801N	LL12801G	G24q3	1x26
	∅ 50 cm - ∅ 19,7 in	LL12802B	LL12802N	LL12802G	G24q3	2x26
	∅ 60 cm - ∅ 23,6 in	LL12803B	LL12803N	LL12803G	G24q3	2x26
	∅ 50 cm - ∅ 19,7 in	LL12812B	LL12812N	LL12812G	Gx24q3	2x32
	∅ 60 cm - ∅ 23,6 in	LL12813B	LL12813N	LL12813G	Gx24q3	2x32
	∅ 80 cm - ∅ 31,5 in	LL12804B	LL12804N	LL12804G	2G11	2x36+1x55

LED		220-240V - 3000K - CRI >80			C€ IP20		
	dimensions	code			total absorbtion	lumen Led board	
		bianco white	bianco / nero white / black	bianco / grigio white / grey			
sospensione <i>hanging</i>	∅ 40 cm - ∅ 15,7 in	LD121103B	LD121103N	LD121103G	16W	1502lm	
	∅ 50 cm - ∅ 19,7 in	LD121203B	LD121203N	LD121203G	25W	2117lm	
	∅ 60 cm - ∅ 23,6 in	LD121303B	LD121303N	LD121303G	41W	3791lm	
	∅ 80 cm - ∅ 31,5 in	LD121403B	LD121403N	LD121403G	74W	7200lm	

LED dimmerabile <i>dimnable</i>		220-240V - 3000K - CRI >80			C€ IP20			
	dimensions	code			total absorbtion	lumen Led board	dimmer	
		bianco white	bianco / nero white / black	bianco / grigio white / grey				
sospensione <i>hanging</i>	∅ 40 cm - ∅ 15,7 in	LD123103B	LD123103N	LD123103G	0-16W	0-1502lm	1/10V	
	∅ 50 cm - ∅ 19,7 in	LD123203B	LD123203N	LD123203G	0-25W	0-2117lm	1/10V	
	∅ 60 cm - ∅ 23,6 in	LD123303B	LD123303N	LD123303G	0-41W	0-3791lm	1/10V	

LED emergenza <i>emergency</i>		220-240V - 3000K - CRI >80			C€ IP20		
	dimensions	code			total absorbtion	lumen Led board	
		bianco white	bianco / nero white / black	bianco / grigio white / grey			
sospensione <i>hanging</i>	∅ 50 cm - ∅ 19,7 in	LD124203B	LD124203N	LD124203G	6-25W	470lm-2117lm	
	∅ 60 cm - ∅ 23,6 in	LD124303B	LD124303N	LD124303G	12-41W	760lm-3791lm	

LED 2700K / 4000K su richiesta - *on request*

Possibilità di colori su richiesta con quantitativi minimi - *Colour options on request with minimum quantities*



Colori
Colours



RAL 9003
Bianco opaco
Matt white



RAL 9005
Nero opaco
Matt black



RAL 7047
Grigio opaco
Matt grey

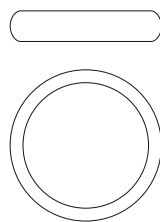

110 - 115 - 115 - 120 cm
4,3 - 4,5 - 4,5 - 4,7 in

40 - 50 - 60 - 80 cm
15,7 - 19,7 - 23,6 - 31,5 in

E27		220-240V			C€		
	dimensions	code			IP	lamp connection	Watt max
		bianco white	bianco / nero white / black	bianco / grigio white / grey			
parete soffitto wall ceiling	∅ 40 cm - ∅ 15,7 in	LL120103B	LL120103N	LL120103G	IP44	E27	1x42HS
	∅ 50 cm - ∅ 19,7 in	LL120203B	LL120203N	LL120203G	IP44	E27	2x42HS
	∅ 60 cm - ∅ 23,6 in	LL120303B	LL120303N	LL120303G	IP44	E27	3x42HS
	∅ 80 cm - ∅ 31,5 in	LL120403B	LL120403N	LL120403G	IP20	E27	5x52HS

FLUO		220-240V			C€		
	dimensions	code			IP	lamp connection	Watt max
		bianco white	bianco / nero white / black	bianco / grigio white / grey			
parete soffitto wall ceiling	∅ 40 cm - ∅ 15,7 in	LL12901B	LL12901N	LL12901G	IP44	G24q3	1x26
	∅ 50 cm - ∅ 19,7 in	LL12902B	LL12902N	LL12902G	IP44	G24q3	2x26
	∅ 60 cm - ∅ 23,6 in	LL12903B	LL12903N	LL12903G	IP44	G24q3	2x26
	∅ 50 cm - ∅ 19,7 in	LL12912B	LL12912N	LL12912G	IP44	Gx24q3	2x32
	∅ 60 cm - ∅ 23,6 in	LL12913B	LL12913N	LL12913G	IP44	Gx24q3	2x32
	∅ 80 cm - ∅ 31,5 in	LL12904B	LL12904N	LL12904G	IP20	2G11	2x36+1x55

LED		220-240V - 3000K - CRI >80			C€ IP20		
	dimensions	code			IP	total absorbtion	lumen Led board
		bianco white	bianco / nero white / black	bianco / grigio white / grey			
parete soffitto wall ceiling	∅ 40 cm - ∅ 15,7 in	LD120103B	LD120103N	LD120103G	IP44	16W	1502lm
	∅ 50 cm - ∅ 19,7 in	LD120203B	LD120203N	LD120203G	IP44	25W	2117lm
	∅ 60 cm - ∅ 23,6 in	LD120303B	LD120303N	LD120303G	IP44	41W	3791lm
	∅ 80 cm - ∅ 31,5 in	LD120403B	LD120403N	LD120403G	IP20	74W	7200lm

LED dimmerabile <i>dimnable</i>		220-240V - 3000K - CRI >80			C€ IP44		
	dimensions	code			total absorbtion	lumen Led board	dimmer
		bianco white	bianco / nero white / black	bianco / grigio white / grey			
parete soffitto wall ceiling	∅ 40 cm - ∅ 15,7 in	LD126103B	LD126103N	LD126103G	0-16W	0-1502lm	1/10V
	∅ 50 cm - ∅ 19,7 in	LD126203B	LD126203N	LD126203G	0-25W	0-2117lm	1/10V
	∅ 60 cm - ∅ 23,6 in	LD126303B	LD126303N	LD126303G	0-41W	0-3791lm	1/10V

LED emergenza <i>emergency</i>		220-240V - 3000K - CRI >80			C€ IP44		
	dimensions	code			total absorbtion	lumen Led board	
		bianco white	bianco / nero white / black	bianco / grigio white / grey			
parete soffitto wall ceiling	∅ 50 cm - ∅ 19,7 in	LD127203B	LD127203N	LD127203G	6-25W	470lm-2117lm	
	∅ 60 cm - ∅ 23,6 in	LD127303B	LD127303N	LD127303G	12-41W	760lm-3791lm	

LED 2700K / 4000K su richiesta - *on request*

Possibilità di colori su richiesta con quantitativi minimi - *Colour options on request with minimum quantities*



Drum

Attacco baionetta
Bayonett attack

Parete
Soffitto

Wall
Ceiling

Collezione di lampade da parete e soffitto in vetro soffiato triplex opale satinato, con recuperatore di flusso in alluminio gofrato, base in policarbonato anti UV traslucido neutro resistente al cloro. Disponibile nel colore base neutro e nei colori rosso, arancione, blu, verde e giallo. Chiusura vetro a baionetta.

La collezione Drum ha un grado di protezione IP44 ed è particolarmente indicata per piscine e ambienti umidi in genere.

A collection of wall and ceiling lamps in satin finish triplex opal blown glass, with embossed aluminium flux recuperator, and a chlorine-resistant, anti-UV, neutral translucent polycarbonate base. Available with a neutral, red, orange, blue, green or yellow base. Twist-lock coupling system for the glass component.

The Drum collection has IP44 protection, making it ideal for use in swimming pools and humid environments in general.





Drum

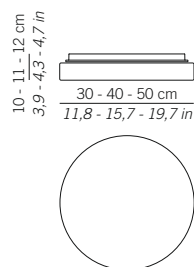

E27		220-240V		C€ IP44					
dimensions		codice (colore base in policarbonato) - code (polycarbonate base colour)					lamp connection	Watt max	
		trasparente transparent	rosso red	arancio orange	blu blue	verde green	giallo yellow		
parete soffitto wall ceiling	∅ 30 cm - ∅ 11,8 in	LL8701NE	LL8701RO	LL8701AR	LL8701BL	LL8701VE	LL8701GI	E27	1x42HS
	∅ 40 cm - ∅ 15,7 in	LL8731NE	LL8731RO	LL8731AR	LL8731BL	LL8731VE	LL8731GI	E27	2x42HS
	∅ 50 cm - ∅ 19,7 in	LL8761NE	LL8761RO	LL8761AR	LL8761BL	LL8761VE	LL8761GI	E27	3x42HS

FLUO		220-240V		C€ IP44					
dimensions		codice (colore base in policarbonato) - code (polycarbonate base colour)					lamp connection	Watt max	
		trasparente transparent	rosso red	arancio orange	blu blue	verde green	giallo yellow		
parete soffitto wall ceiling	∅ 30 cm - ∅ 11,8 in	LL8711NE	LL8711RO	LL8711AR	LL8711BL	LL8711VE	LL8711GI	G24q-3	1x26
	∅ 40 cm - ∅ 15,7 in	LL8741NE	LL8741RO	LL8741AR	LL8741BL	LL8741VE	LL8741GI	G24q-3	2x26
	∅ 50 cm - ∅ 19,7 in	LL8771NE	LL8771RO	LL8771AR	LL8771BL	LL8771VE	LL8771GI	G24q-3	2x26
	∅ 40 cm - ∅ 15,7 in	LL8743NE	LL8743RO	LL8743AR	LL8743BL	LL8743VE	LL8743GI	Gx24q-3	2x32
	∅ 50 cm - ∅ 19,7 in	LL8744NE	LL8744RO	LL8744AR	LL8744BL	LL8744VE	LL8744GI	Gx24q-3	2x32

FLUO emergenza <i>emergency</i>		220-240V		C€ IP44					
dimensions		codice (colore base in policarbonato) - code (polycarbonate base colour)					lamp connection	Watt max	
		trasparente transparent	rosso red	arancio orange	blu blue	verde green	giallo yellow		
parete soffitto wall ceiling	∅ 40 cm - ∅ 15,7 in	LL8742NE	LL8742RO	LL8742AR	LL8742BL	LL8742VE	LL8742GI	G24q-3	2x26
	∅ 50 cm - ∅ 19,7 in	LL8772NE	LL8772RO	LL8772AR	LL8772BL	LL8772VE	LL8772GI	G24q-3	2x26

Emergenza Versione con dispositivo di emergenza per l'alimentazione in luce permanente di una lampada. Autonomia 1h.
Emergency Version with emergency device for powering one permanent lamp. Autonomy 1 hour.

LED		220-240V - 3000K - CRI >80		C€ IP44					
dimensions		codice (colore base in policarbonato) - code (polycarbonate base colour)					total absorbtion	lumen Led board	
		trasparente transparent	rosso red	arancio orange	blu blue	verde green	giallo yellow		
parete soffitto wall ceiling	∅ 30 cm - ∅ 11,8 in	LD8701N3	LD8701R03	LD8701AR3	LD8701BL3	LD8701VE3	LD8701GI3	16W	1502lm
	∅ 40 cm - ∅ 15,7 in	LD8731N3	LD8731R03	LD8731AR3	LD8731BL3	LD8731VE3	LD8731GI3	25W	2117lm
	∅ 50 cm - ∅ 19,7 in	LD8761N3	LD8761R03	LD8761AR3	LD8761BL3	LD8761VE3	LD8761GI3	41W	3791lm

LED dimmerabile <i>dimnable</i>		220-240V - 3000K - CRI >80		C€ IP44					
dimensions		codice (colore base in policarbonato) - code (polycarbonate base colour)					total absorbtion	lumen Led board dimmer	
		trasparente transparent	rosso red	arancio orange	blu blue	verde green	giallo yellow		
parete soffitto wall ceiling	∅ 30 cm - ∅ 11,8 in	LD8703N3	LD8703R03	LD8703AR3	LD8703BL3	LD8703VE3	LD8703GI3	0-16W	0-1502lm 1/10V
	∅ 40 cm - ∅ 15,7 in	LD8733N3	LD8733R03	LD8733AR3	LD8733BL3	LD8733VE3	LD8733GI3	0-25W	0-2117lm 1/10V
	∅ 50 cm - ∅ 19,7 in	LD8763N3	LD8763R03	LD8763AR3	LD8763BL3	LD8763VE3	LD8763GI3	0-41W	0-3791lm 1/10V

LED emergenza <i>emergency</i>		220-240V - 3000K - CRI >80		C€ IP44					
dimensions		codice (colore base in policarbonato) - code (polycarbonate base colour)					total absorbtion	lumen Led board	
		trasparente transparent	rosso red	arancio orange	blu blue	verde green	giallo yellow		
parete soffitto wall ceiling	∅ 40 cm - ∅ 15,7 in	LD8742N3	LD8742R03	LD8742AR3	LD8742BL3	LD8742VE3	LD8742GI3	6-25W	470lm-2117lm
	∅ 50 cm - ∅ 19,7 in	LD8772N3	LD8772R03	LD8772AR3	LD8772BL3	LD8772VE3	LD8772GI3	12-41W	760lm-3791lm

LED 2700K / 4000K su richiesta - on request

Drum metal

Parete
Soffitto

Wall
Ceiling

Attacco baionetta
Twist-lock coupling

Collezione di lampade da parete e soffitto in vetro soffiato triplex opale satinato, con recuperatore di flusso in alluminio goffrato, base in policarbonato anti UV traslucido neutro. Parti metalliche disponibili nelle finiture cromo, verniciato bianco o nero opaco, verniciato lucido nei colori rosso, arancione, blu o verde. Chiusura vetro a baionetta. La collezione Drum metal ha un grado di protezione IP44.

A collection of wall and ceiling lamps in satin finish triplex opal blown glass, with an embossed aluminium flux recuperator, and anti-UV, neutral translucent polycarbonate base. Metal parts are available in the following finishes: chrome, matt black or white painted, glossy red, orange, blue or green painted. Twist-lock system for the glass component. The Drum metal collection has IP44 protection.



10 - 11 - 12 cm
3,9 - 4,3 - 4,7 in



30 - 40 - 50 cm
11,8 - 15,7 - 19,7 in

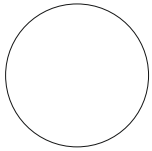

E27		220-240V		C€ IP44						
	dimensions	code						lamp connection	Watt max	
		cromo chrome	bianco white	rosso red	arancio orange	blu blue	verde green			nero black
parete soffitto wall ceiling	ø 30 cm-ø 11,8 in	LL8701C	LL8701B	LL8701MRO	LL8701MAR	LL8701MBL	LL8701MVE	LL8701MNE	E27	1x42HS
	ø 40 cm-ø 15,7 in	LL8731C	LL8731B	LL8731MRO	LL8731MAR	LL8731MBL	LL8731MVE	LL8731MNE	E27	2x42HS
	ø 50 cm-ø 19,7 in	LL8761C	LL8761B	LL8761MRO	LL8761MAR	LL8761MBL	LL8761MVE	LL8761MNE	E27	3x42HS

FLUO		220-240V		C€ IP44						
	dimensions	code						lamp connection	Watt max	
		cromo chrome	bianco white	rosso red	arancio orange	blu blue	verde green			nero black
parete soffitto wall ceiling	ø 30 cm-ø 11,8 in	LL8711C	LL8711B	LL8711MRO	LL8711MAR	LL8711MBL	LL8711MVE	LL8711MNE	G24q-3	1x26
	ø 40 cm-ø 15,7 in	LL8741C	LL8741B	LL8741MRO	LL8741MAR	LL8741MBL	LL8741MVE	LL8741MNE	G24q-3	2x26
	ø 50 cm-ø 19,7 in	LL8771C	LL8771B	LL8771MRO	LL8771MAR	LL8771MBL	LL8771MVE	LL8771MNE	G24q-3	2x26
	ø 50 cm-ø 19,7 in	LL8772C	LL8772B	LL8772MRO	LL8772MAR	LL8772MBL	LL8772MVE	LL8772MNE	Gx24q-3	2x32

LED		220-240V - 3000K - CRI >80		C€ IP44						
	dimensions	code						total absorbtion	lumen Led board	
		cromo chrome	bianco white	rosso red	arancio orange	blu blue	verde green			nero black
parete soffitto wall ceiling	ø 30 cm-ø 11,8 in	LD8701C3	LD8701B3	LD8701MRO3	LD8701MAR3	LD8701MBL3	LD8701MVE3	LD8701MNE3	16W	1502lm
	ø 40 cm-ø 15,7 in	LD8731C3	LD8731B3	LD8731MRO3	LD8731MAR3	LD8731MBL3	LD8731MVE3	LD8731MNE3	25W	2117lm
	ø 50 cm-ø 19,7 in	LD8761C3	LD8761B3	LD8761MRO3	LD8761MAR3	LD8761MBL3	LD8761MVE3	LD8761MNE3	41W	3791lm

LED		dimmerabile <i>dimnable</i>		220-240V - 3000K - CRI >80		C€ IP44					
	dimensions	code						total absorbtion	lumen Led board dimmer		
		cromo chrome	bianco white	rosso red	arancio orange	blu blue	verde green		nero black		
parete soffitto wall ceiling	ø 30 cm-ø 11,8 in	LD8711C3	LD8711B3	LD8711MRO3	LD8711MAR3	LD8711MBL3	LD8711MVE3	LD8711MNE3	0-16W	0-1502lm	1/10V
	ø 40 cm-ø 15,7 in	LD8733C3	LD8733B3	LD8733MRO3	LD8733MAR3	LD8733MBL3	LD8733MVE3	LD8733MNE3	0-25W	0-2117lm	1/10V
	ø 50 cm-ø 19,7 in	LD8763C3	LD8763B3	LD8763MRO3	LD8763MAR3	LD8763MBL3	LD8763MVE3	LD8763MNE3	0-41W	0-3791lm	1/10V

LED		emergenza <i>emergency</i>		220-240V - 3000K - CRI >80		C€ IP44					
	dimensions	code						total absorbtion	lumen Led board		
		cromo chrome	bianco white	rosso red	arancio orange	blu blue	verde green		nero black		
parete soffitto wall ceiling	ø 40 cm-ø 15,7 in	LD8743C3	LD8743B3	LD8743MRO3	LD8743MAR3	LD8743MBL3	LD8743MVE3	LD8743MNE3	6-25W	470-2117lm	
	ø 50 cm-ø 19,7 in	LD8745C3	LD8745B3	LD8745MRO3	LD8745MAR3	LD8745MBL3	LD8745MVE3	LD8745MNE3	12-41W	760-3791lm	

LED 2700K / 4000K su richiesta - *on request*

Possibilità di colori su richiesta con quantitativi minimi - *Colour options on request with minimum quantities*

Drum bayonet

Attacco baionetta
Twist-lock coupling

Parete
Soffitto

Wall
Ceiling

Collezione di lampade da parete e soffitto in vetro soffiato triplex opale satinato. Parti metalliche verniciate bianco. Chiusura vetro a baionetta.

A collection of wall and ceiling lamps in satin finish triplex opal blown glass. White painted metal parts. Twist-lock system for the glass component.



10 - 11 - 12 cm
3,9 - 4,3 - 4,7 in

30 - 40 - 50 - 70 cm
11,8 - 15,7 - 19,7 - 27,6 in

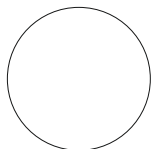

E27		220-240V		CE IP20
	dimensions	code	lamp connection	Watt max
parete soffitto wall ceiling	∅ 30 cm - ∅ 11,8 in	LL8910	E27	1x52HS
	∅ 40 cm - ∅ 15,7 in	LL8911	E27	2x52HS
	∅ 50 cm - ∅ 19,7 in	LL8912	E27	3x52HS
	∅ 70 cm - ∅ 27,6 in	LL8913	E27	5x52HS

FLUO		220-240V		CE IP20
	dimensions	code	lamp connection	Watt max
parete soffitto wall ceiling	∅ 30 cm - ∅ 11,8 in	LL8920	Gx24q-3	1x26
	∅ 40 cm - ∅ 15,7 in	LL8921	G24q-3	1x26
	∅ 50 cm - ∅ 19,7 in	LL8922	G24q-3	2x26
	∅ 50 cm - ∅ 19,7 in	LL8923	Gx24q-3	2x32
	∅ 70 cm - ∅ 27,6 in	LL8924	2G11	2x36 / 1x55

LED		220-240V - 3000K - CRI >80		CE IP20
	dimensions	code	total absorbtion	lumen Led board
parete soffitto wall ceiling	∅ 30 cm - ∅ 11,8 in	LD891003	16W	1502lm
	∅ 40 cm - ∅ 15,7 in	LD891103	25W	2117lm
	∅ 50 cm - ∅ 19,7 in	LD891203	41W	3791lm
	∅ 70 cm - ∅ 27,6 in	LD891303	74W	7200lm

LED dimmerabile <i>dimnable</i>		220-240V - 3000K - CRI >80		CE IP20
	dimensions	code	total absorbtion	lumen Led board dimmer
parete soffitto wall ceiling	∅ 30 cm - ∅ 11,8 in	LD893003	0-16W	0-1502lm 1/10V
	∅ 40 cm - ∅ 15,7 in	LD893103	0-25W	0-2117lm 1/10V
	∅ 50 cm - ∅ 19,7 in	LD893203	0-41W	0-3791lm 1/10V

LED emergenza <i>emergency</i>		220-240V - 3000K - CRI >80		CE IP20
	dimensions	code	total absorbtion	lumen Led board
parete soffitto wall ceiling	∅ 40 cm - ∅ 15,7 in	LD894103	6-25W	470-2117lm
	∅ 50 cm - ∅ 19,7 in	LD894203	12-41W	760-3791lm



Minidrum

Parete
Soffitto

Wall
Ceiling

Collezione di lampade in vetro soffiato triplex opale satinato con fonte luminosa a LED.
E' disponibile nelle due versioni, da incasso con alimentatore in remoto e da superficie con alimentatore nella base, entrambe a parete e soffitto. Parti metalliche cromate.

*A collection of lamps in satin finish triplex opal blown glass with a LED light source.
Available in two versions: recessed with a remote power adaptor or surface-mounted with a power adaptor in the base. Both versions are available in a wall and ceiling version. Chrome metal parts.*



Versione da incasso con alimentatore in remoto.
Version with recessed remote power adaptor.

Versione con alimentatore nella base.
Version with power adaptor in the base.

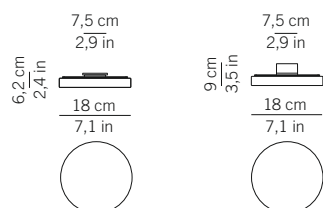

LED		220-240V - 3000K - CRI >80	CE IP20
	dimensions	code cromo chrome	total absorbtion lumen Led board
incasso parete soffitto recessed wall ceiling	ø 18 h 6,2 cm - ø 7,1 h 2,4 in	LD7701C3...	8W 700lm

...IP44 su richiesta - on request

LED		220-240V - 3000K - CRI >80	CE IP20
	dimensions	code cromo chrome	total absorbtion lumen Led board
plafone parete soffitto wall and ceiling-mounted lamp	ø 18 h 9 cm - ø 7,1 h 3,5 in	LD7702C3	4W 320lm

Bis

Attacco baionetta. Base in policarbonato.
Twist-lock coupling. Polycarbonate base.

Parete
Soffitto

Wall
Ceiling

Collezione di lampade da parete e soffitto in vetro soffiato triplex opale satinato, con recuperatore di flusso in alluminio gofrato, base in policarbonato anti UV traslucido neutro resistente al cloro. Disponibile nel colore base neutro e nei colori rosso, arancione, blu, verde e giallo. Chiusura vetro a baionetta. La collezione Bis ha un grado di protezione IP44 ed è particolarmente indicata per piscine e ambienti umidi in genere.

A collection of wall and ceiling lamps in satin finish triplex opal blown glass, with embossed aluminium flux recuperator, and a chlorine-resistant, anti-UV, neutral translucent polycarbonate base. Available with a neutral, red, orange, blue, green or yellow base. Twist-lock system for the glass component. The Bis collection has IP44 protection, making it ideal for use in swimming pools and humid environments in general.







Bis

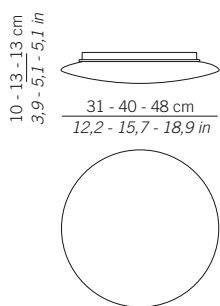

E27		220-240V		C€ IP44					
dimensions		codice (colore base in policarbonato) - code (polycarbonate base colour)						lamp connection	Watt max
		trasparente transparent	rosso red	arancio orange	blu blue	verde green	giallo yellow		
parete soffitto wall ceiling	∅ 31 cm - ∅ 12,2 in	LL6111NE	LL6111RO	LL6111AR	LL6111BL	LL6111VE	LL6111GI	E27	1x42HS
	∅ 40 cm - ∅ 15,7 in	LL6112NE	LL6112RO	LL6112AR	LL6112BL	LL6112VE	LL6112GI	E27	2x42HS
	∅ 48 cm - ∅ 18,9 in	LL6113NE	LL6113RO	LL6113AR	LL6113BL	LL6113VE	LL6113GI	E27	3x42HS

FLUO		220-240V		C€ IP44					
dimensions		codice (colore base in policarbonato) - code (polycarbonate base colour)						lamp connection	Watt max
		trasparente transparent	rosso red	arancio orange	blu blue	verde green	giallo yellow		
parete soffitto wall ceiling	∅ 31 cm - ∅ 12,2 in	LL6115NE	LL6115RO	LL6115AR	LL6115BL	LL6115VE	LL6115GI	G24q-3	1x26
	∅ 40 cm - ∅ 15,7 in	LL6116NE	LL6116RO	LL6116AR	LL6116BL	LL6116VE	LL6116GI	G24q-3	2x26
	∅ 48 cm - ∅ 18,9 in	LL6117NE	LL6117RO	LL6117AR	LL6117BL	LL6117VE	LL6117GI	G24q-3	2x26
	∅ 48 cm - ∅ 18,9 in	LL6118NE	LL6118RO	LL6118AR	LL6118BL	LL6118VE	LL6118GI	Gx24q-3	2x32

LED		220-240V - 3000K - CRI >80		C€ IP44					
dimensions		codice (colore base in policarbonato) - code (polycarbonate base colour)						total absorbtion	lumen Led board
		trasparente transparent	rosso red	arancio orange	blu blue	verde green	giallo yellow		
parete soffitto wall ceiling	∅ 31 cm - ∅ 12,2 in	LD6111NE	LD6111RO	LD6111AR	LD6111BL	LD6111VE	LD6111GI	16W	1502lm
	∅ 40 cm - ∅ 15,7 in	LD6112NE	LD6112RO	LD6112AR	LD6112BL	LD6112VE	LD6112GI	25W	2117lm
	∅ 48 cm - ∅ 18,9 in	LD6113NE	LD6113RO	LD6113AR	LD6113BL	LD6113VE	LD6113GI	41W	3791lm

LED dimmerabile <i>dimnable</i>		220-240V - 3000K - CRI >80		C€ IP44					
dimensions		codice (colore base in policarbonato) - code (polycarbonate base colour)						total absorbtion	lumen Led board dimmer
		trasparente transparent	rosso red	arancio orange	blu blue	verde green	giallo yellow		
parete soffitto wall ceiling	∅ 31 cm - ∅ 12,2 in	LD613103NE	LD613103RO	LD613103AR	LD613103BL	LD613103VE	LD613103GI	0-16W	0-1502lm 1/10V
	∅ 40 cm - ∅ 15,7 in	LD613203NE	LD613203RO	LD613203AR	LD613203BL	LD613203VE	LD613203GI	0-25W	0-2117lm 1/10V
	∅ 48 cm - ∅ 18,9 in	LD612003NE	LD612003RO	LD612003AR	LD612003BL	LD612003VE	LD612003GI	0-41W	0-3791lm 1/10V

LED emergenza <i>emergency</i>		220-240V - 3000K - CRI >80		C€ IP44					
dimensions		codice (colore base in policarbonato) - code (polycarbonate base colour)						total absorbtion	lumen Led board
		trasparente transparent	rosso red	arancio orange	blu blue	verde green	giallo yellow		
parete soffitto wall ceiling	∅ 40 cm - ∅ 15,7 in	LD612603NE	LD612603RO	LD612603AR	LD612603BL	LD612603VE	LD612603GI	6-25W	470lm-2117lm
	∅ 48 cm - ∅ 18,9 in	LD612703NE	LD612703RO	LD612703AR	LD612703BL	LD612703VE	LD612703GI	12-41W	760lm-3791lm

Bis bayonet

Attacco baionetta
Twist-lock coupling

Parete
Soffitto

Wall
Ceiling

Collezione di lampade da parete e soffitto in vetro soffiato triplex opale satinato. Parti metalliche verniciate bianco. Chiusura vetro a baionetta.

A collection of wall and ceiling lamps in satin finish triplex opal blown glass. White painted metal parts. Twist-lock system for the glass component.



9 - 9 - 10 - 11 cm
3,5 - 3,5 - 3,9 - 4,3 in



25 - 31 - 40 - 48 cm
9,8 - 12,2 - 15,7 - 18,9 in

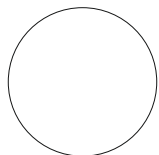

E27		220-240V	C€ IP20	
	dimensions	code	lamp connection	Watt max
parete soffitto wall ceiling	∅ 25 cm - ∅ 9,8 in	LL6110	E27	1x42HS
	∅ 31 cm - ∅ 12,2 in	LL6111	E27	1x52HS
	∅ 40 cm - ∅ 15,7 in	LL6112	E27	2x52HS
	∅ 48 cm - ∅ 18,9 in	LL6113	E27	3x52HS

FLUO		220-240V	C€ IP20	
	dimensions	code	lamp connection	Watt max
parete soffitto wall ceiling	∅ 31 cm - ∅ 12,2 in	LL6115	Gx24q-3	1x26
	∅ 40 cm - ∅ 15,7 in	LL6116	G24q-3	1x26
	∅ 48 cm - ∅ 18,9 in	LL6117	G24q-3	2x26
	∅ 48 cm - ∅ 18,9 in	LL6118	Gx24q-3	2x32

LED		220-240V - 3000K - CRI >80	C€ IP20	
	dimensions	code	total absorption	lumen Led board
parete soffitto wall ceiling	∅ 25 cm - ∅ 9,8 in	LD611003	13W	911lm
	∅ 31 cm - ∅ 12,2 in	LD611103	16W	1502lm
	∅ 40 cm - ∅ 15,7 in	LD611203	25W	2117lm
	∅ 48 cm - ∅ 18,9 in	LD611303	41W	3791lm

LED dimmerabile <i>dimnable</i>		220-240V - 3000K - CRI >80	C€ IP20		
	dimensions	code	total absorption	lumen Led board dimmer	
parete soffitto wall ceiling	∅ 31 cm - ∅ 12,2 in	LD613103	0-16W	0-1502lm	1/10V
	∅ 40 cm - ∅ 15,7 in	LD613203	0-25W	0-2117lm	1/10V
	∅ 48 cm - ∅ 18,9 in	LD612003	0-41W	0-3791lm	1/10V

LED emergenza <i>emergency</i>		220-240V - 3000K - CRI >80	C€ IP20	
	dimensions	code	total absorption	lumen Led board
parete soffitto wall ceiling	∅ 40 cm - ∅ 15,7 in	LD612603	6-25W	470lm-2117lm
	∅ 48 cm - ∅ 18,9 in	LD612703	12-41W	760lm-3791lm



Minibis

Parete
Soffitto

Wall
Ceiling

Collezione di lampade in vetro soffiato triplex opale satinato con fonte luminosa a LED.
E' disponibile nelle due versioni, da incasso con alimentatore in remoto e da superficie con alimentatore nella base, entrambe a parete e soffitto. Parti metalliche cromate.

*A collection of lamps in satin finish triplex opal blown glass with a LED light source.
Available in two versions: recessed with a remote power adaptor or surface-mounted with a power adaptor in the base. Both versions are available in a wall and ceiling version. Chrome metal parts.*



Versione da incasso con alimentatore in remoto.
Version with recessed remote power adaptor.

Versione con alimentatore nella base.
Version with power adaptor in the base.

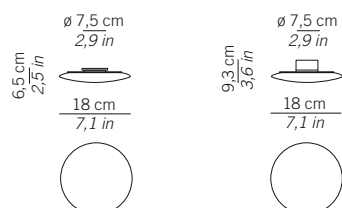

LED		220-240V - 3000K - CRI >80	CE IP20
	dimensions	code cromo chrome	total absorbtion lumen Led board
incasso parete soffitto recessed wall ceiling	Ø 18 h 6,5 cm - Ø 7,1 h 2,5 in	LD7501C3...	8W 700lm

...IP44 su richiesta - on request

LED		220-240V - 3000K - CRI >80	CE IP20
	dimensions	code cromo chrome	total absorbtion lumen Led board
plafone parete soffitto wall and ceiling-mounted lamp	Ø 18 h 9,3 cm - Ø 7,1 h 3,6 in	LD7502C3	4W 320lm

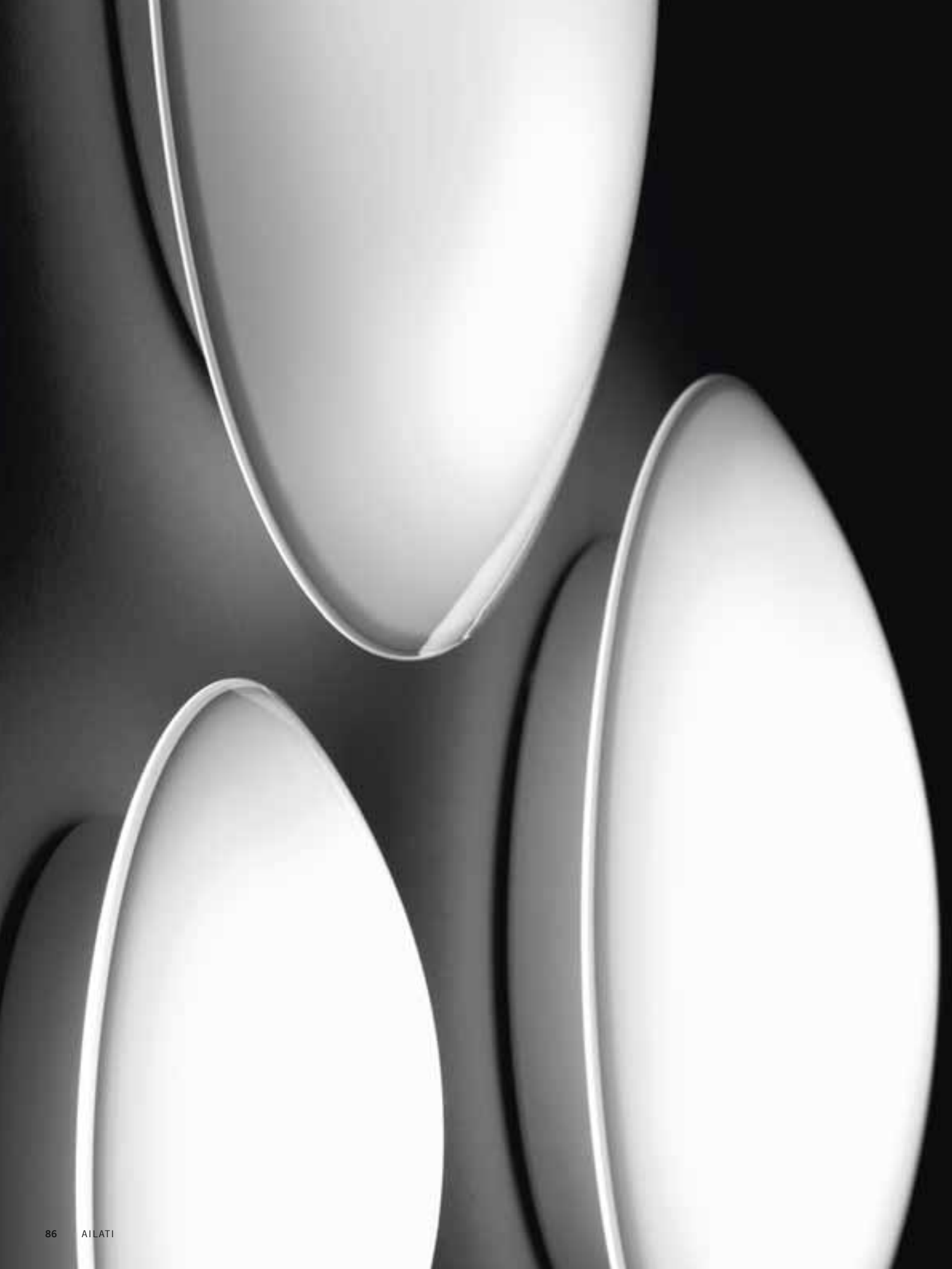

Clara

Parete
Soffitto

Wall
Ceiling

Collezione di lampade a parete e soffitto in vetro soffiato triplex opale lucido con particolare lavorazione a filo cristallo. Parti metalliche verniciate bianco.

A collection of wall and ceiling lamps in gloss triplex opal blown glass, with special crystal glass edge detail. White painted metal parts.

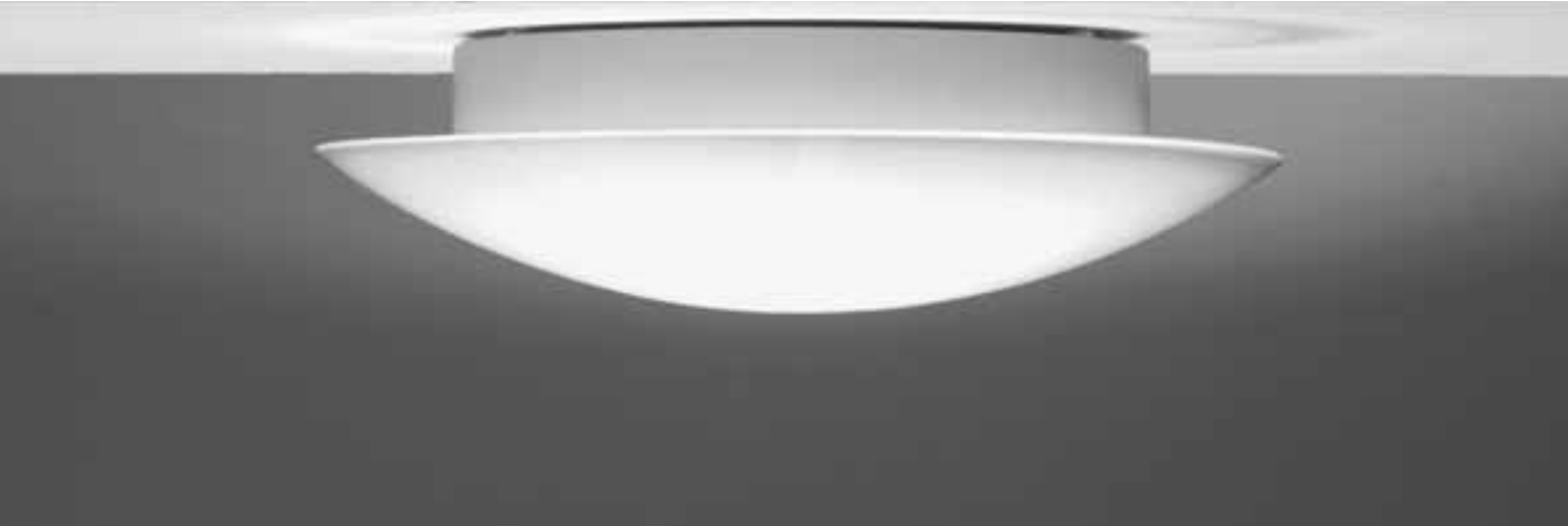



Clara

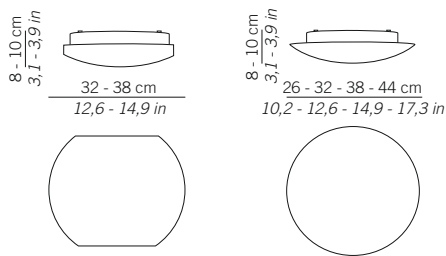

E27		220-240V		C€ IP20	
	dimensions	code	lamp connection	Watt max	
parete (con vetro aperto) wall (with open glass)	Ø 32 cm - Ø 12,6 in	LL9140	E27	1x42HS	
	Ø 38 cm - Ø 14,9 in	LL9150	E27	2x42HS	
parete soffitto wall ceiling	Ø 26 cm - Ø 10,2 in	LL9100	E27	1x42HS	
	Ø 32 cm - Ø 12,6 in	LL9110	E27	1x42HS	
	Ø 38 cm - Ø 14,9 in	LL9120	E27	2x42HS	
	Ø 44 cm - Ø 17,3 in	LL9130	E27	2x52HS	

LED		220-240V - 3000K - CRI >80		C€ IP20	
	dimensions	code trasparente transparent	total absorption	lumen Led board	
parete wall	Ø 32 cm - Ø 12,6 in	LD914003	13W	911lm	
	Ø 38 cm - Ø 14,9 in	LD915003	16W	1502lm	
parete soffitto wall ceiling	Ø 26 cm - Ø 10,2 in	LD910003	13W	911lm	
	Ø 32 cm - Ø 12,6 in	LD911003	13W	911lm	
	Ø 38 cm - Ø 14,9 in	LD912003	16W	1502lm	
	Ø 44 cm - Ø 17,3 in	LD913003	25W	2117lm	

LED dimmerabile <i>dimnable</i>		220-240V - 3000K - CRI >80		C€ IP20	
	dimensions	code trasparente transparent	total absorption	lumen Led board dimmer	
parete soffitto wall ceiling	Ø 38 cm - Ø 14,9 in	LD912103	0-16W	0-1502lm	1/10V
	Ø 44 cm - Ø 17,3 in	LD913503	0-25W	0-2117lm	1/10V

LED emergenza <i>emergency</i>		220-240V - 3000K - CRI >80		C€ IP20	
	dimensions	code trasparente transparent	total absorption	lumen Led board	
parete soffitto wall ceiling	Ø 44 cm - Ø 17,3 in	LD916103	6-25W	470-2117lm	



Chiusa

Collezione di lampade a parete e soffitto in vetro soffiato triplex opale satinato. Parti metalliche verniciate bianco.

A collection of wall and ceiling lamps in satin finish triplex opal blown glass. White painted metal parts.

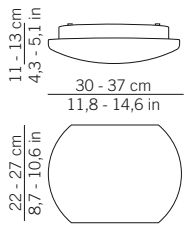

E27		220-240V		CE IP20
	dimensions	code	lamp connection	Watt max
parete soffitto	∅ 30 cm - ∅ 11,8 in	LL5500	E27	1x42HS
wall ceiling	∅ 37 cm - ∅ 14,6 in	LL5501	E27	2x42HS

LED		220-240V - 3000K - CRI >80		CE IP20
	dimensions	code	total absorption	lumen Led board
parete soffitto	∅ 30 cm - ∅ 11,8 in	LD550003	13W	911lm
wall ceiling	∅ 37 cm - ∅ 14,6 in	LD550103	13W	911lm

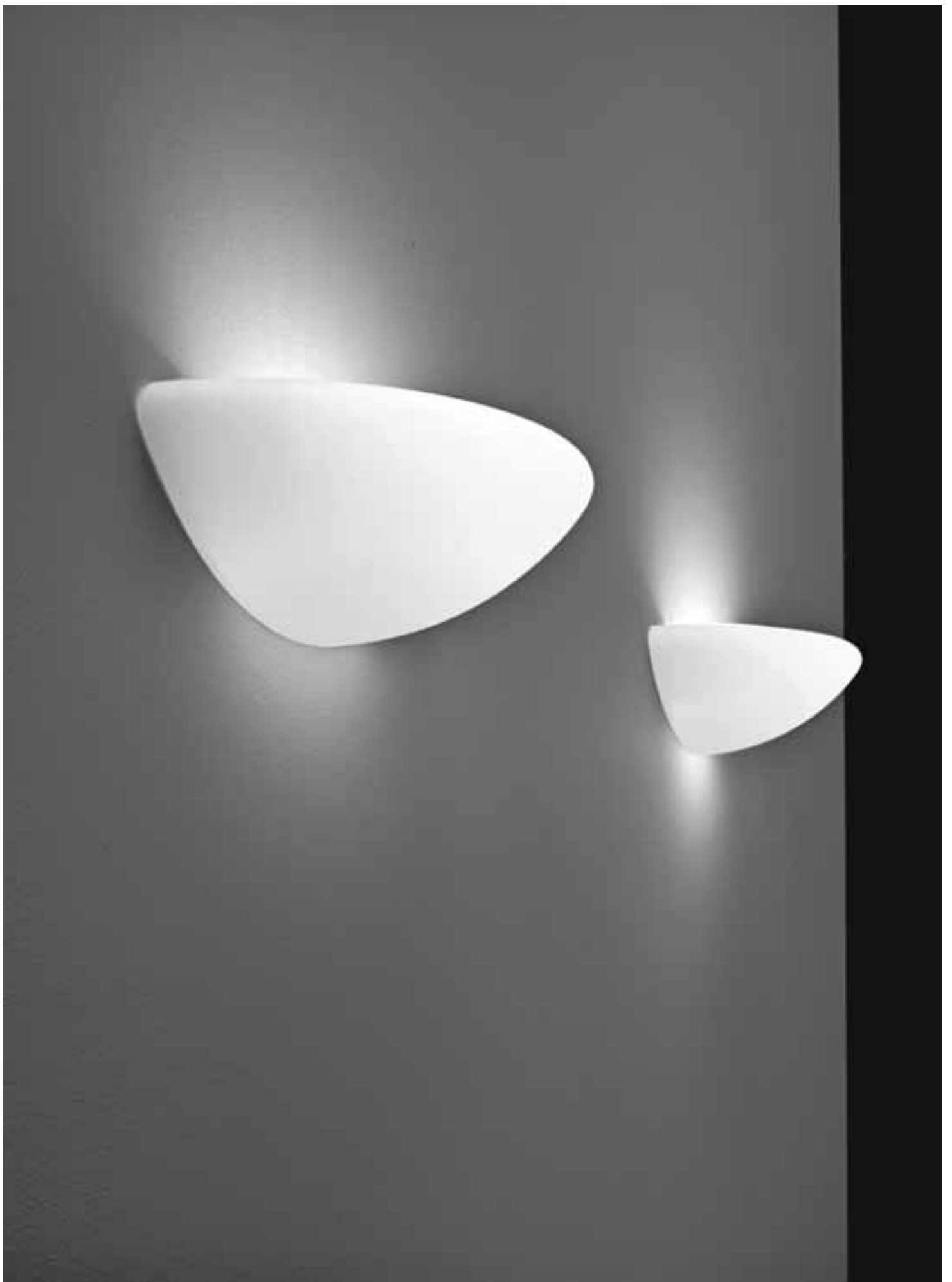

Spicchio

Parete

Wall

Collezione di lampade a parete in vetro soffiato triplex opale satinato.
Parti metalliche verniciate bianco e viti di fissaggio vetro cromo.

*A collection of wall lamps in satin finish triplex opal blown glass.
Matt white painted metal parts and chrome fixing screws for the glass component.*

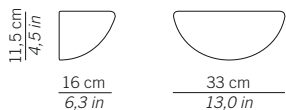

HALO	220-240V		C € IP20		
	dimensions	code	lamp connection	Watt max	bulb size
parete wall	L 33 cm - L 13 in	LL5000	R7s	1x120HS	7,8 cm - 3,07 in

E14	220-240V		C € IP20		
	dimensions	code	lamp connection	Watt max	
parete wall	L 33 cm - L 13 in	LL5001	E14	2x42HS	

LED	220-240V - 3000K - CRI >80		C € IP20		
	dimensions	code	total absorbtion	lumen Led board	
parete wall	L 33 cm - L 13 in	LD5000 cromo chrome	9W	800lm	



Box rotonda

Parete
Soffitto

Wall
Ceiling
Round

Collezione di lampade a parete e soffitto in vetro extrachiaro satinato, con recuperatore di flusso in alluminio gofrato, base in policarbonato anti UV traslucido neutro resistente al cloro. Disponibile nel colore base neutro e nei colori rosso, arancione, blu, verde e giallo. La collezione Box ha un grado di protezione IP43.

A collection of wall and ceiling lamps in satin finish extra clear glass, with an embossed aluminium flux recuperator, and a chlorine-resistant, anti-UV, neutral translucent polycarbonate base. Available with a neutral, red, orange, blue, green or yellow base. The Box collection has IP43 protection.

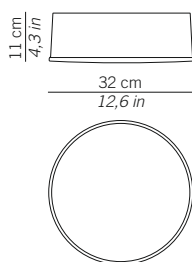

E27		220-240V						CE IP43	
dimensions		codice (colore base in policarbonato) - code (polycarbonate base colour)						lamp connection Watt max	
		trasparente	rosso	arancio	blu	verde	giallo		
		transparent	red	orange	blue	green	yellow		
parete soffitto	ø 32 cm - ø 12,6 in	LL8411NE	LL8411RO	LL8411AR	LL8411BL	LL8411VE	LL8411GI	E27	2x42HS
wall ceiling									

FLUO		220-240V						CE IP43	
dimensions		codice (colore base in policarbonato) - code (polycarbonate base colour)						lamp connection Watt max	
		trasparente	rosso	arancio	blu	verde	giallo		
		transparent	red	orange	blue	green	yellow		
parete soffitto	ø 32 cm - ø 12,6 in	LL8421NE	LL8421RO	LL8421AR	LL8421BL	LL8421VE	LL8421GI	G24q-3	2x26
wall ceiling									

LED		220-240V - 3000K - CRI >80						CE IP43	
dimensions		codice (colore base in policarbonato) - code (polycarbonate base colour)						total absorbtion lumen Led board	
		trasparente	rosso	arancio	blu	verde	giallo		
		transparent	red	orange	blue	green	yellow		
parete soffitto	ø 32 cm - ø 12,6 in	LD8411NE3	LD8411RO3	LD8411AR3	LD8411BL3	LD8411VE3	LD8411GI3	25W	2117lm
wall ceiling									

LED dimmerabile <i>dimnable</i>		220-240V - 3000K - CRI >80						CE IP43		
dimensions		codice (colore base in policarbonato) - code (polycarbonate base colour)						total absorbtion lumen Led board dimmer		
		trasparente	rosso	arancio	blu	verde	giallo			
		transparent	red	orange	blue	green	yellow			
parete soffitto	ø 32 cm - ø 12,6 in	LD8413NE3	LD8413RO3	LD8413AR3	LD8413BL3	LD8413VE3	LD8413GI3	0-25W	0-2117lm	1/10V
wall ceiling										

LED 2700K / 4000K su richiesta - on request



Box quadrata

Parete
Soffitto

Wall
Ceiling
Square

Collezione di lampade a parete e soffitto in vetro extrachiaro satinato, con recuperatore di flusso in alluminio gofrato, base in policarbonato anti UV traslucido neutro resistente al cloro. Disponibile nel colore base neutro e nei colori rosso, arancione, blu, verde e giallo. La collezione Box ha un grado di protezione IP43.

A collection of wall and ceiling lamps in satin finish extra clear glass, with an embossed aluminium flux recuperator, and a chlorine-resistant, anti-UV, neutral translucent polycarbonate base. Available with a neutral, red, orange, blue, green or yellow base. The Box collection has IP43 protection.

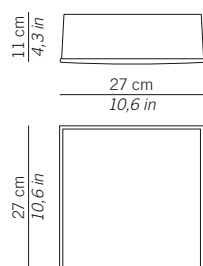

E27		220-240V					CE IP43	
dimensions	codice (colore base in policarbonato) - code (polycarbonate base colour)					lamp connection	Watt max	
	trasparente	rosso	arancio	blu	verde	giallo		
	transparent	red	orange	blue	green	yellow		
parete soffitto wall ceiling	27x27 cm - 10,6x10,6 in	LL8461NE	LL8461RO	LL8461AR	LL8461BL	LL8461VE	LL8461GI	E27 2x42HS

FLUO		220-240V					CE IP43	
dimensions	codice (colore base in policarbonato) - code (polycarbonate base colour)					lamp connection	Watt max	
	trasparente	rosso	arancio	blu	verde	giallo		
	transparent	red	orange	blue	green	yellow		
parete soffitto wall ceiling	27x27 cm - 10,6x10,6 in	LL8471NE	LL8471RO	LL8471AR	LL8471BL	LL8471VE	LL8471GI	G24q-3 2x26

LED		220-240V - 3000K - CRI >80					CE IP43	
dimensions	codice (colore base in policarbonato) - code (polycarbonate base colour)					total absorbtion	lumen Led board	
	trasparente	rosso	arancio	blu	verde	giallo		
	transparent	red	orange	blue	green	yellow		
parete soffitto wall ceiling	27x27 cm - 10,6x10,6 in	LD8461NE3	LD8461RO3	LD8461AR3	LD8461BL3	LD8461VE3	LD8461GI3	25W 2117lm

LED dimmerabile <i>dimnable</i>		220-240V - 3000K - CRI >80					CE IP43	
dimensions	codice (colore base in policarbonato) - code (polycarbonate base colour)					total absorbtion	lumen Led board	dimmer
	trasparente	rosso	arancio	blu	verde	giallo		
	transparent	red	orange	blue	green	yellow		
parete soffitto wall ceiling	27x27 cm - 10,6x10,6 in	LD8463NE3	LD8463RO3	LD8463AR3	LD8463BL3	LD8463VE3	LD8463GI3	0-25W 0-2117lm 1/10V

LED 2700K / 4000K su richiesta - on request



Eclipse tonda

Collezione di lampade a incasso e soffitto in due forme, con corpo in pressofusione di alluminio verniciato bianco opaco e diffusore in policarbonato satinato. Eclipse è la combinazione perfetta di due sorgenti di luce, con un unico e innovativo driver a 3 vie facilmente controllabile tramite interruttore oppure nella normale versione ON-OFF. Il funzionamento della lampada nella prima versione è SMD per illuminazione indiretta, COB per illuminazione diretta e SMD+COB per illuminazione totale. Nella seconda versione SMD+COB illuminazione totale in un'unica soluzione. Eclipse si distingue per l'aspetto elegante, il design lineare, una funzione intelligente e innovativa.

A collection of recessed and ceiling lamps in two shapes, with a matt white painted die-cast aluminium fixture and a satin finish polycarbonate diffuser. Eclipse is the ideal combination of two light sources, with a unique and innovative 3-way driver, easily controlled with a switch, or available in a standard ON-OFF version.

The first version is operated with an SMD switch for indirect lighting, with a COB for direct lighting, and an SMD+COB for total lighting. The second version, instead, offers a single solution with SMD+COB for total lighting. Eclipse makes a statement with its elegant appearance, smooth design, and smart and innovative control function.

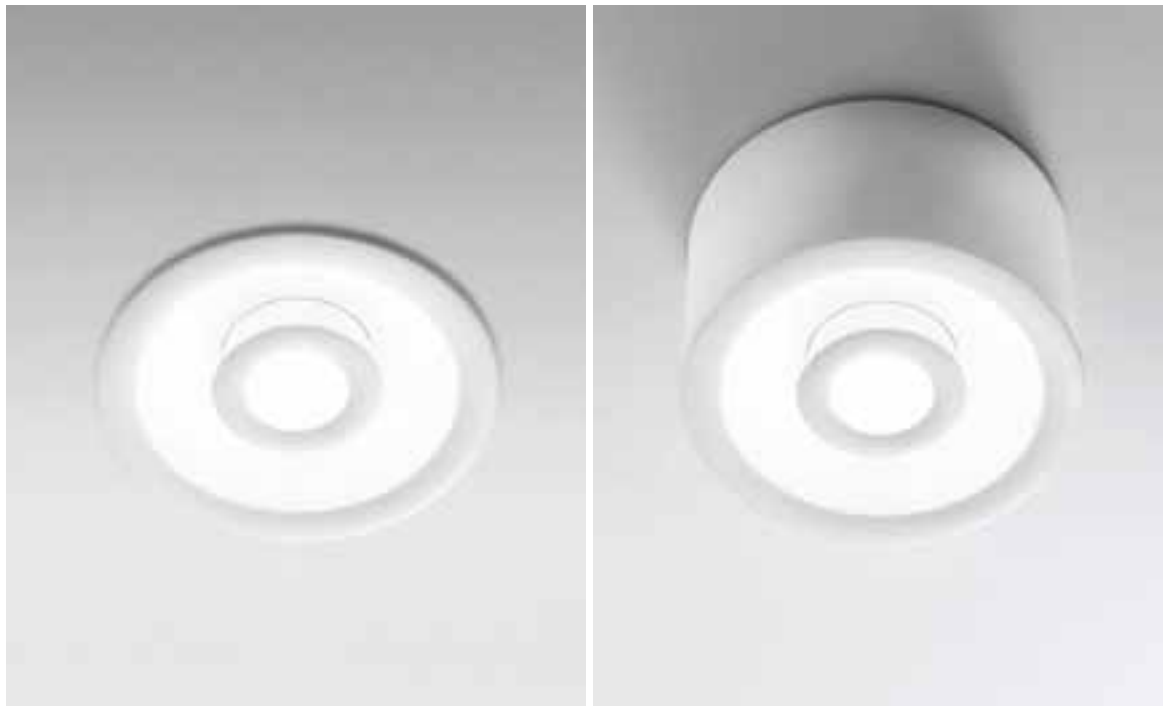

Incasso *Recessed*

Soffitto *Ceiling*

Eclipse tonda

Incasso
Recessed



STEP 1 (SMD)

STEP 2 (COB)

STEP 3 (SMD+COB)

La lampada è controllata da un unico interruttore, con ogni ciclo di accensione ravvicinato cambia tipologia di illuminazione.

STEP 1 (SMD) - STEP 2 (COB) - STEP 3 (SMD+ COB)

Lasciando la lampada spenta per un tempo prolungato alla sua riaccensione parte sempre dallo STEP 1.

The lamp is controlled by a single switch, the type of illumination changes with each ignition cycle.

STEP 1 (SMD) - STEP 2 (COB) - STEP 3 (SMD+ COB)

Leaving the lamp off, for a longer period, to its restart always starts from STEP 1.

LED	200-240V - 3000K - CRI >80		C € IP20			
	dimensions	code	power Led	total absorbtion	lumen lamp	hole for fitting
incasso	ø 12x3,5 cm - ø 4,7x1,4 in	LD0010B3	6,8+6,8W	7+7W	142+557lm	11 cm - 4,3 in
recessed	ø 17,8x3,5 cm - ø 7x1,4 in	LD0012B3	13,6+13,6W	14+14W	434+1015lm	16 cm - 2,3 in

Alimentatore compreso - power adaptor included

LED	versione on-off <i>on-off version</i>	100-240V - 3000K - CRI >80		C € IP20		
	dimensions	code	power Led	total absorbtion	lumen lamp	hole for fitting
incasso	ø 12x3,5 cm - ø 4,7x1,4 in	LD0016B3	13,6W	14W	697lm	11 cm - 4,3 in
recessed	ø 17,8x3,5 cm - ø 7x1,4 in	LD0017B3	27,2W	28W	1446lm	16 cm - 2,3 in

Nuovi prodotti con unica accensione - new products with single ignition

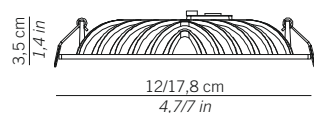



Eclipse tonda

Soffitto
Ceiling

STEP 1 (SMD)

STEP 2 (COB)

STEP 3 (SMD+COB)

La lampada è controllata da un unico interruttore, con ogni ciclo di accensione ravvicinato cambia tipologia di illuminazione.

STEP 1 (SMD) - STEP 2 (COB) - STEP 3 (SMD+ COB)

Lasciando la lampada spenta per un tempo prolungato alla sua riaccensione parte sempre dallo STEP 1.

The lamp is controlled by a single switch, the type of illumination changes with each ignition cycle.

STEP 1 (SMD) - STEP 2 (COB) - STEP 3 (SMD+ COB)

If the lamp is switched off for a longer period, it always starts again from STEP 1.

LED	200-240V - 3000K - CRI >80		CE IP20		
	dimensions	code	power Led	total absorbtion	lumen lamp
soffitto	ø 12x6,5 cm - ø 4,7x2,5 in	LD0001B3	6,8+6,8W	7+7W	142+557lm
ceiling	ø 17,8x6,5 cm - ø 7x2,5 in	LD0003B3	13,6+13,6W	14+14W	434+1015lm

LED	versione on-off <i>on-off version</i>	100-240V - 3000K - CRI >80		CE IP20	
	dimensions	code	power Led	total absorbtion	lumen lamp
soffitto	ø 12x6,5 cm - ø 4,7x2,5 in	LD0002B3	13,6W	14W	697lm
ceiling	ø 17,8x6,5 cm - ø 7x2,5 in	LD0005B3	27,2W	28W	1446lm

Nuovi prodotti con unica accensione - *new products with single ignition*

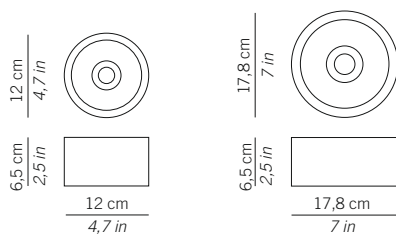



Eclipse quadra

Collezione di lampade a incasso e soffitto in due forme, con corpo in pressofusione di alluminio verniciato bianco opaco e diffusore in policarbonato satinato. Eclipse è la combinazione perfetta di due sorgenti di luce, con un unico e innovativo driver a 3 vie facilmente controllabile tramite interruttore oppure nella normale versione ON-OFF. Il funzionamento della lampada nella prima versione è SMD per l'illuminazione indiretta, COB per illuminazione diretta e SMD+COB per illuminazione totale. Nella seconda versione SMD+COB illuminazione totale in un'unica soluzione. Eclipse si distingue per l'aspetto elegante, il design lineare, una funzione intelligente e innovativa.

A collection of recessed and ceiling lamps in two shapes, with a matt white painted die-cast aluminium fixture and a satin finish polycarbonate diffuser. Eclipse is the ideal combination of two light sources, with a unique and innovative 3-way driver, easily controlled with a switch, or available in a standard ON-OFF version.

The first version is operated with an SMD switch for indirect lighting, with a COB for direct lighting, and an SMD+COB for total lighting. The second version, instead, offers a single solution with SMD+COB for total lighting. Eclipse makes a statement with its elegant appearance, smooth design, and smart and innovative control function.

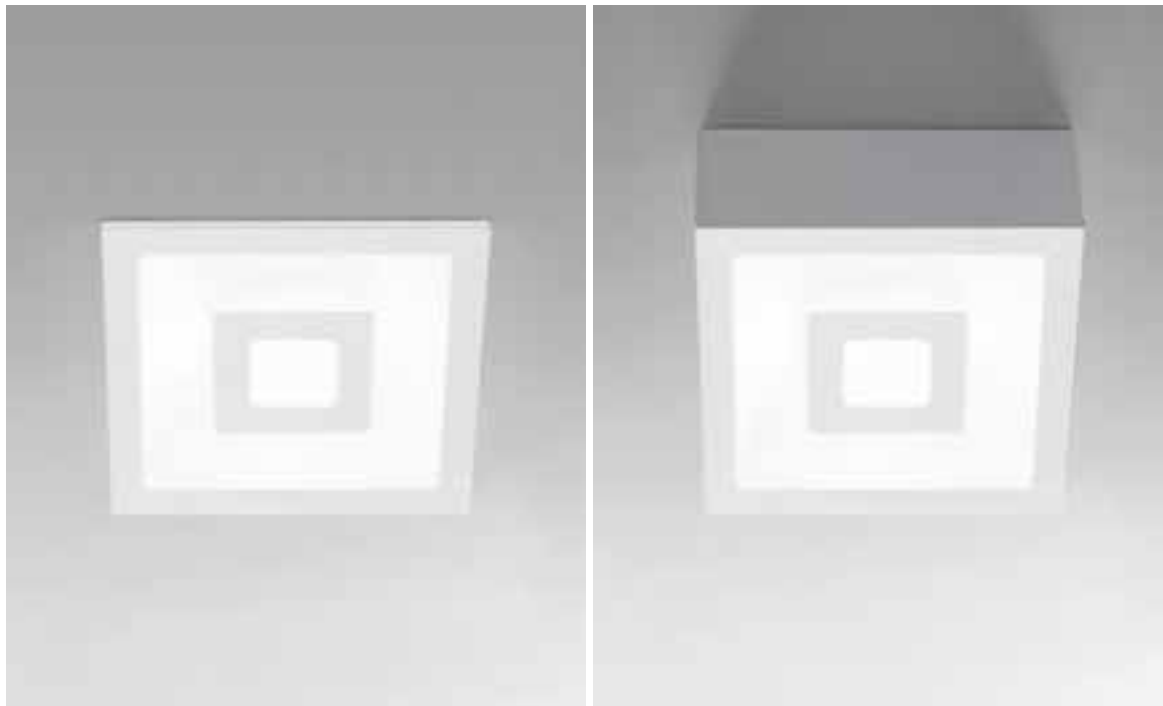

Incasso Recessed

Soffitto Ceiling

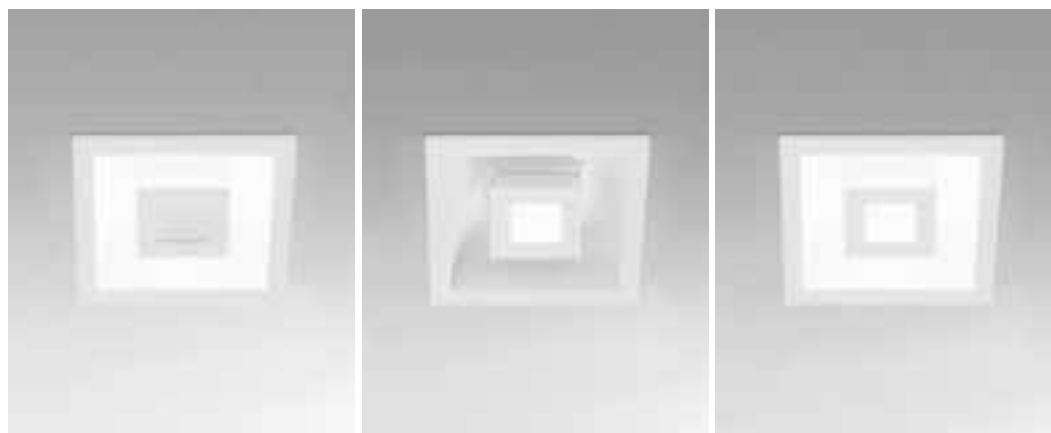

STEP 1 (SMD)

STEP 2 (COB)

STEP 3 (SMD+COB)

Eclipse quadra

Incasso
Recessed

La lampada è controllata da un unico interruttore, con ogni ciclo di accensione ravvicinato cambia tipologia di illuminazione.

STEP 1 (SMD) - STEP 2 (COB) - STEP 3 (SMD+ COB)

Lasciando la lampada spenta per un tempo prolungato alla sua riaccensione parte sempre dallo STEP 1.

The lamp is controlled by a single switch, the type of illumination changes with each ignition cycle.

STEP 1 (SMD) - STEP 2 (COB) - STEP 3 (SMD+ COB)

If the lamp is switched off for a longer period, it always starts again from STEP 1.

LED	200-240V - 3000K - CRI >80			CE IP20		
	dimensions	code	power Led	total absorbtion	lumen lamp	hole for fitting
incasso	12x12x3,5 cm - 4,7x4,7x1,4 in	LD0013B3	6,8+6,8W	7+7W	142+557lm	10,5x10,5 cm - 4,1x4,1 in
recessed	17,8x17,8x3,5 cm - 7x7x1,4 in	LD0015B3	13,6+13,6W	14+14W	434+1015lm	16x16 cm - 2,3x2,3 in

Alimentatore compreso - power adaptor included

LED	versione on-off	on-off version	100-240V - 3000K - CRI >80		CE IP20	
	dimensions	code	power Led	total absorbtion	lumen lamp	hole for fitting
incasso	12x12x3,5 cm - 4,7x4,7x1,4 in	LD0018B3	13,6W	14W	697lm	10,5x10,5 cm - 4,1x4,1 in
recessed	17,8x17,8x3,5 cm - 7x7x1,4 in	LD0019B3	27,2W	28W	1446lm	16x16 cm - 2,3x2,3 in

Nuovi prodotti con unica accensione - new products with single ignition

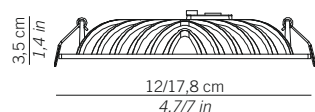

Eclipse quadra

Soffitto
Ceiling



STEP 1 (SMD)

STEP 2 (COB)

STEP 3 (SMD+COB)

La lampada è controllata da un unico interruttore, con ogni ciclo di accensione ravvicinato cambia tipologia di illuminazione.

STEP 1 (SMD) - STEP 2 (COB) - STEP 3 (SMD+ COB)

Lasciando la lampada spenta per un tempo prolungato alla sua riaccensione parte sempre dallo STEP 1.

The lamp is controlled by a single switch, the type of illumination changes with each ignition cycle.

STEP 1 (SMD) - STEP 2 (COB) - STEP 3 (SMD+ COB)

If the lamp is switched off for a longer period, it always starts again from STEP 1.

LED	200-240V - 3000K - CRI >80		CE IP20		
	dimensions	code	power Led	total absorbtion	lumen lamp
soffitto	12x12x6,5 cm - 4,7x4,7x2,5 in	LD0004B3	6,8+6,8W	7+7W	142+557lm
ceiling	17,8x17,8x6,5 cm - 7x7x2,5 in	LD0006B3	13,6+13,6W	14+14W	434+1015lm

LED	versione on-off <i>on-off version</i>	100-240V - 3000K - CRI >80		CE IP20	
	dimensions	code	power Led	total absorbtion	lumen lamp
soffitto	12x12x6,5 cm - 4,7x4,7x2,5 in	LD0007B3	13,6W	14W	697lm
ceiling	17,8x17,8x6,5 cm - 7x7x2,5 in	LD0008B3	27,2W	28W	1446lm

Nuovi prodotti con unica accensione - *new products with single ignition*

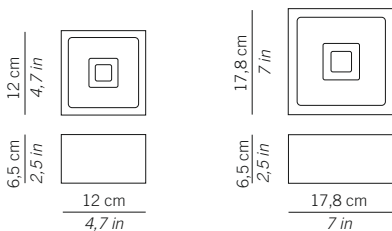



Claretta

Parete

Wall

Collezione di lampade a parete con corpo in pressofusione di alluminio verniciato nei colori bianco opaco o grigio scuro, diffusore in policarbonato bianco e fonte luminosa a LED biemissione. La collezione Claretta ha un grado di protezione IP54 idonea per uso esterno ed interno.

A collection of wall lamps with a matt white or dark grey painted die-cast aluminium fixture, a white polycarbonate diffuser and a double emission LED light source.
The Claretta collection has IP54 protection, making it ideal for internal and external use.

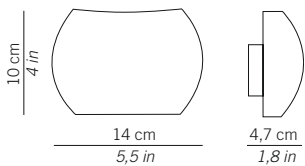

LED		220-240V - 3000K - CRI >80	CE IP54		
	dimensions	code	power Led	total absorbtion	lumen lamp
		bianco white			
		grigio scuro dark grey			
parete wall	14x10x4,7 cm - 5,5x4x1,8 in	LD0020B3	LD0020G3	2x3,4W	2x4W
				2x4W	2x250lm



Ovalino

Parete

Wall

Collezione di lampade a parete con corpo in pressofusione di alluminio verniciato nei colori bianco opaco o grigio scuro, diffusore in policarbonato bianco e fonte luminosa a LED biemissione. La collezione Ovalino ha un grado di protezione IP54 idonea per uso esterno ed interno.

A collection of wall lamps with a matt white or dark grey painted die-cast aluminium fixture, a white polycarbonate diffuser and a double emission LED light source. The Ovalino collection has IP54 protection, making it ideal for internal and external use.

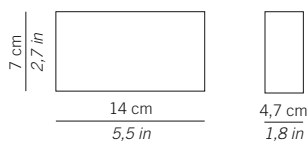

LED		220-240V - 3000K - CRI >80		CE IP54		
	dimensions	code	power Led	total absorbtion	lumen lamp	
		bianco white				
		grigio scuro dark grey				
parete wall	14x7x4,7 cm - 5,5x2,7x1,8 in	LD0030B3	LD0030G3	2x3,4W	2x4W	2x302lm



Astuccio

Parete

Wall

Collezione di lampade a parete con corpo in pressofusione di alluminio verniciato nei colori bianco opaco o grigio scuro, diffusore in policarbonato bianco e fonte luminosa a LED biemissione. La collezione Astuccio ha un grado di protezione IP54 idonea per uso esterno ed interno.

A collection of wall lamps with a matt white or dark grey painted die-cast aluminium fixture, a white polycarbonate diffuser and a double emission LED light source.

The Astuccio collection has IP54 protection, making it ideal for internal and external use.

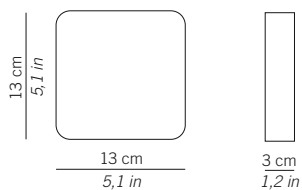

LED		100-240V - 3000K - CRI >80		CE IP54		
	dimensions	code	power Led	total absorbtion	lumen lamp	
		bianco white				
		grigio scuro dark grey				
parete wall	13x13x3 cm - 5,1x5,1x1,2 in	LD0040B3	LD0040G3	2x4,5W	2x5W	2x404lm



Cubetto

Parete

Wall

Collezione di lampade a parete con corpo in pressofusione di alluminio verniciato bianco opaco, diffusore in policarbonato e fonte luminosa a LED. La lampada a parete con grado IP54 è idonea per uso esterno ed interno ed è provvista di regolazione indipendente del fascio luminoso sia sopra che sotto, cover personalizzabile con colori a richiesta.

A collection of wall lamps with a matt white painted die-cast aluminium fixture, a polycarbonate diffuser and a LED light source. The wall lamp with IP54 protection is ideal for internal and external use. It has independent control of the beam of light above and below, with a cover that can be customised in colours on request.





Cubetto

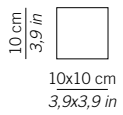
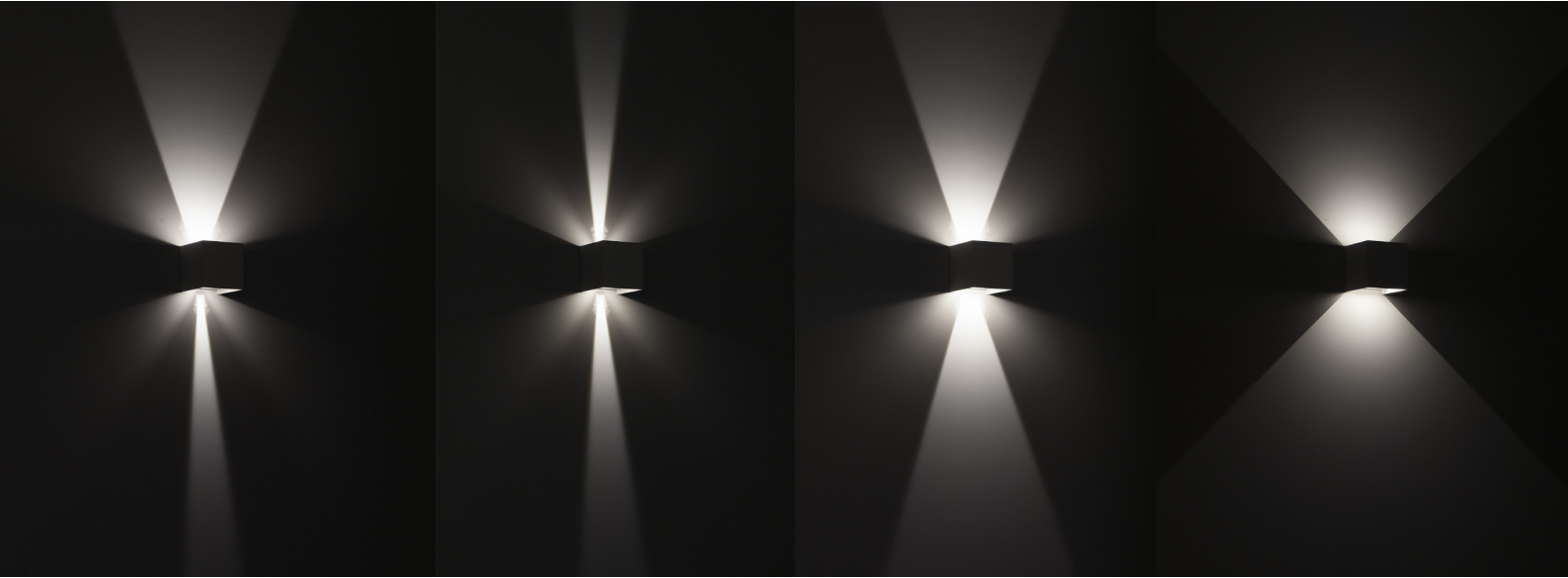

LED		100-240V - 3000K - CRI >80		CE IP54		
	dimensions	code	code	power Led	total absorbtion	lumen lamp
		bianco white	grigio scuro dark gray			
parete wall	10x10x10 cm - 3,9x3,9x3,9 in	LD0052B3	LD0052G3	6W	6,3W	382lm

Personalizzabile RAL su richiesta - *customised RAL colours on request*



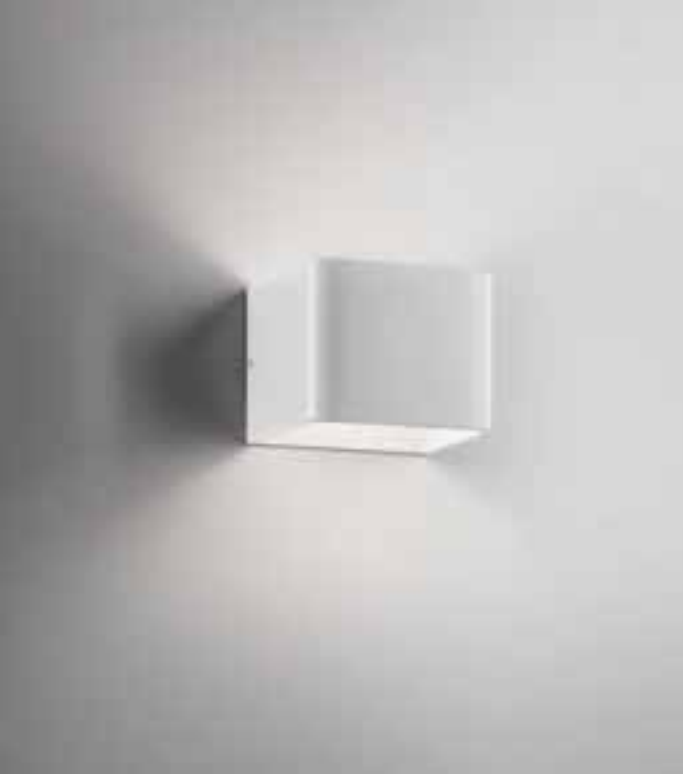

Cubetto



10 cm
3,9 in



10x10 cm
3,9x3,9 in

8 cm
3,1 in



20 cm
7,8 in



10 cm
3,9 in

LED		100-240V - 3000K - CRI >80	CE IP20		
	dimensions	code	power Led	total absorbtion	lumen lamp
parete wall	10x8x10 cm - 3,9x3,1x3,9 in	LD0050B3	6W	6,9W	389lm
parete wall	20x8x10 cm - 7,8x3,1x3,9 in	LD0051B3	12W	13,2W	810lm



Cip

Parete

Wall

Collezione di lampade a parete con corpo in pressofusione di alluminio verniciato bianco opaco, diffusore in policarbonato satinato e fonte luminosa a LED.

A collection of wall lamps with a matt white painted die-cast aluminium fixture, a satin finish polycarbonate diffuser and a LED light source.

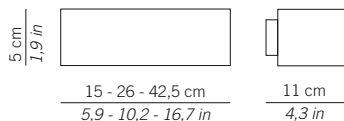

LED		100-240V - 3000K - CRI >80	CE IP20		
	dimensions	code	power Led	total absorbtion	lumen lamp
parete wall	15x5x11 cm - 5,5x1,9x4,3 in	LD0060B3	6W	6,7W	425lm
parete wall	26x5x11 cm - 10,2x1,9x4,3 in	LD0061B3	12W	12,5W	767lm
parete wall	42,5x5x11 cm - 16,7x1,9x4,3 in	LD0062B3	16W	16,6W	772lm



Bridge

Parete

Wall

Collezione di lampade a parete con corpo in pressofusione di alluminio verniciato bianco opaco e fonte luminosa a LED.

A collection of wall lamps with a matt white painted die-cast aluminium fixture and a LED light source.

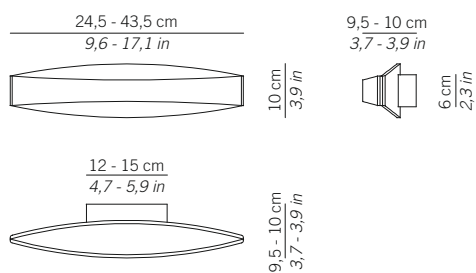
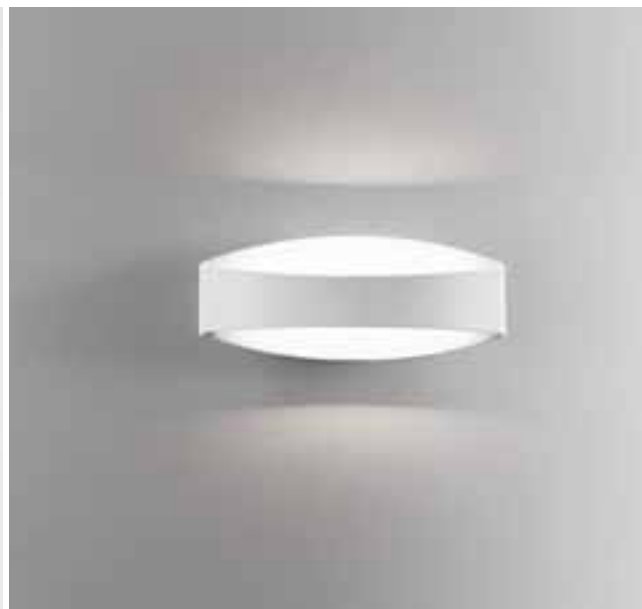

LED		100-240V - 3000K - CRI >80	CE IP20		
	dimensions	code	power Led	total absorbtion	lumen lamp
parete wall	24,5x10x9,5 cm - 9,6x3,9x3,7 in	LD0080B3	8W	8,6W	549lm
	43,5x10x10 cm - 17,1x3,9x3,9 in	LD0081B3	16W	16,8W	1137lm

Stripe

Parete
Soffitto

Wall
Ceiling

Collezione di lampade a parete e soffitto con corpo in alluminio verniciato bianco opaco, diffusore in policarbonato satinato e fonte luminosa a LED. La collezione Stripe magneto ha un particolare sistema di fissaggio del corpo lampada alla staffa di supporto. Questo sistema semplifica e velocizza l'installazione.

A collection of wall and ceiling lamps with a matt white painted aluminium fixture, a satin finish polycarbonate diffuser and a LED light source. The Stripe magneto collection has a special system for fixing the lamp fixture to the support bracket. This system simplifies and speeds up installation.

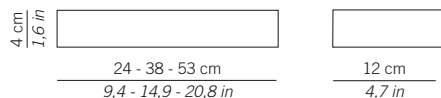

LED		100-240V - 3000K - CRI >80	CE IP20		
	dimensions	code	power Led	total absorbtion	lumen lamp
		bianco white			
parete wall	24x4x12 cm - 9,4x1,6x4,7 in	LD0070B3	6W	6,7W	496lm
parete wall	38x4x12 cm - 14,9x1,6x4,7 in	LD0071B3	12W	13W	992lm
parete wall	53x4x12 cm - 20,8x1,6x4,7 in	LD0072B3	18W	20W	1488lm

Stripe magneto

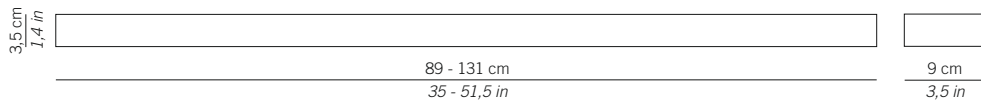

LED	versione megneto <i>magnetic version</i>	220-240V - 3000K - CRI >80	CE IP20		
	dimensions	code	power Led	total absorbtion	lumen lamp
		bianco white			
parete soffitto	89x3,5x9 cm - 35x1,4x3,5 in	LD0076B3	27W	28,2W	2114lm
wall ceiling	131x3,5x9 cm - 51,5x1,4x3,5 in	LD0077B3	35W	37W	2780lm



Stripe





Mine

Parete
Soffitto

Wall
Ceiling

Collezione di lampade a parete e soffitto con corpo in pressofusione di alluminio verniciato nei colori bianco o nero opaco, diffusore in policarbonato bianco e fonte luminosa a LED.

A collection of wall and ceiling lamps with a matt white or black painted die-cast aluminium fixture, a white polycarbonate diffuser and a LED light source.



ø 9-12-14 cm
ø 3,5-4,7-5,5 in



LED		100-240V - 3000K - CRI >80	CE IP20			
	dimensions	code	power Led	total absorbtion	lumen lamp	
		bianco white	nero black			
soffitto ceiling	ø 9x5,7 cm - ø 3,5x2,2 in	LD0090B3	LD0090N3	6W	7,8W	470lm
parete wall	ø 12x5,7 cm - ø 4,7x2,2 in	LD0091B3	LD0091N3	12W	13,2W	921lm
	ø 14x5,7 cm - ø 5,5x2,2 in	LD0092B3	LD0092N3	18W	20W	1442lm





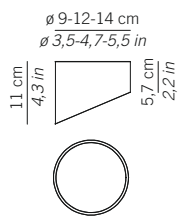

LED		100-240V - 3000K - CRI >80		CE IP20		
	dimensions	code		power Led	total absorbtion	lumen lamp
		bianco white	nero black			
soffitto <i>ceiling</i>	$\varnothing 9 \times 11$ cm - $\varnothing 3,5 \times 4,3$ in	LD0094B3	LD0094N3	6W	7,8W	444lm
parete <i>wall</i>	$\varnothing 12 \times 11$ cm - $\varnothing 4,7 \times 4,3$ in	LD0095B3	LD0095N3	12W	13,2W	856lm
	$\varnothing 14 \times 11$ cm - $\varnothing 5,5 \times 4,3$ in	LD0096B3	LD0096N3	18W	20W	1338lm

Riga

Parete
Sospensione

Wall
Hanging

Collezione di lampade a sospensione e parete con corpo in pressofusione di alluminio verniciato bianco opaco, diffusore in policarbonato satinato e fonte luminosa a LED monoemissione o biemissione.

A collection of hanging and wall lamps with a matt white painted die-cast aluminium fixture, a satin finish polycarbonate diffuser and a single emission or double emission LED light source.







MONO EMISSIONE

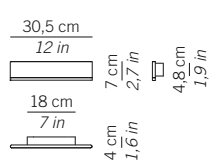

MONO EMISSIONE

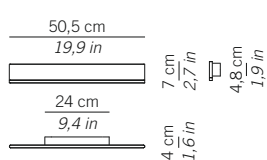

MONO EMISSIONE

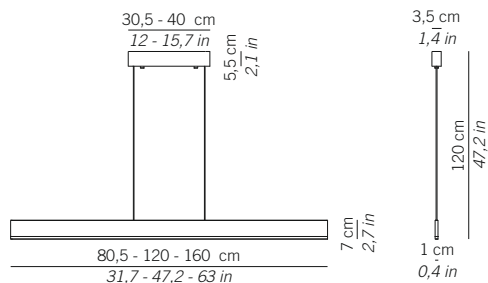

BI EMISSIONE

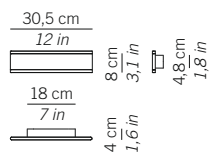

BI EMISSIONE

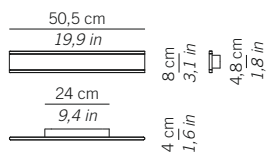

LED

3000K - CRI >80

CE IP20

	dimensions	code	power Led	total absorption	lumen lamp	
sospensione hanging	80,5x1x120 cm - 31,7x0,4x47,2 in	LD0100B3	25W	26,7W	1889 lm	220-240V
	120x1x120 cm - 47,2x0,4x47,2 in	LD0101B3	36W	38,5W	2686lm	220-240V
	160x1x120 cm - 63x0,4x47,2 in	LD0102B3	48W	52,0W	3593lm	220-240V
parete wall	30,5x7x4 cm - 12x2,7x1,6 in	LD0104B3	8W	8,6W	572lm	100-240V
	30,5x8x4 cm - 12x3,1x1,6 in	LD0105B3	2x8W	2x8,6W	2x572lm	100-240V
	50,5x7x4 cm - 19,9x2,7x1,6 in	LD0106B3	12W	13,2W	911lm	100-240V
	50,5x8x4 cm - 19,9x3,1x1,6 in	LD0107B3	2x12W	2x13,2W	2x911lm	100-240V



Collezione di lampade a parete con corpo in pressofusione di alluminio verniciato bianco opaco, diffusore in policarbonato satinato e fonte luminosa a LED monoemissione o biemissione. La collezione Ciclope ha un grado di protezione IP54 idonea per uso esterno ed interno.

A collection of wall lamps with a matt white painted die-cast aluminium fixture, a satin finish polycarbonate diffuser and a single emission or double emission LED light source. The Ciclope collection has IP54 protection, making it ideal for internal and external use.

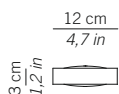
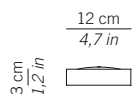

LED		220-240V - 3000K - CRI >80	CE IP54		
	dimensions	code	power Led	total absorption	lumen lamp
parete wall	12x12x3 cm - 4,7x4,7x1,2 in	LD0110B3	6W	6W	467lm
	12x12x3 cm - 4,7x4,7x1,2 in	LD0111B3	2x6W	2x6W	2x467lm



Collezione di lampade a soffitto con corpo in pressofusione di alluminio verniciato bianco opaco, diffusore in policarbonato trasparente e fonte luminosa a LED.

A collection of ceiling lamps with a matt white painted die-cast aluminium fixture, a clear polycarbonate diffuser and a LED light source.

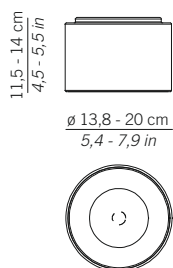

LED

100-240V - 3000K - CRI >80

CE IP20

	dimensions	code	power Led	total absorption	lumen lamp
soffitto ceiling	Ø 13,8x11,5 cm - Ø 5,4x4,5 in	LD0121B3	15W	15,4W	1431lm
	Ø 20x14 cm - Ø 7,9x5,5 in	LD0123B3	30W	31,5W	3562lm

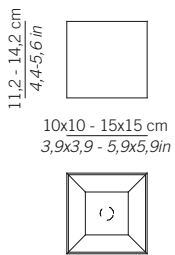

LED	100-240V - 3000K - CRI >80		CE IP20		
	dimensions	code	power Led	total absorbtion	lumen lamp
soffitto <i>ceiling</i>	10x10x11,2 cm - 3,9x3,9x4,4 in	LD0126B3	15W	15,4W	1408lm
	15x15x14,2 cm - 5,9x5,9x5,6 in	LD0128B3	30W	31,5W	3544lm

Alu

Parete
Soffitto

Wall
Ceiling

Collezione di lampade a soffitto e parete con corpo in pressofusione di alluminio verniciato nei colori bianco opaco o grigio scuro, diffusore in policarbonato bianco e fonte luminosa a LED. La collezione Alu ha un grado di protezione IP54 idonea per uso esterno ed interno.

*A collection of ceiling and wall lamps with a matt white or dark grey painted die-cast aluminium fixture, a white polycarbonate diffuser and a LED light source.
The Alu collection has IP54 protection, making it ideal for internal and external use.*











Alu

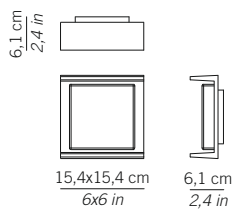

LED		220-240V - 3000K - CRI >80		C € IP54		
	dimensions	code		power Led	total absorbtion	lumen lamp
		bianco white	nero black			
parete wall	15,4x15,4x6,1 cm - 6x6x2,4 in	LD0138B3	LD0138G3	7W	10W	600lm

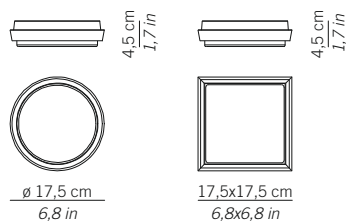

LED		220-240V - 3000K - CRI >80		C € IP54		
	dimensions	code		power Led	total absorbtion	lumen lamp
		bianco white	nero black			
parete soffitto wall ceiling	∅ 17,5x4,5 cm - ∅ 6,8x1,7 in	LD0130B3	LD0130G3	8,4W	10W	650lm
	17,5x17,5x4,5 cm - 6,8x6,8x1,7 in	LD0135B3	LD0135G3	8,4W	10W	650lm

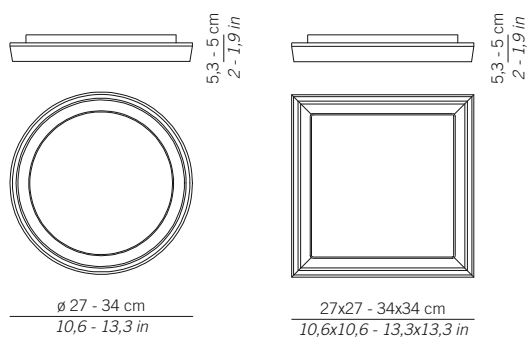

LED		220-240V - 3000K - CRI >80		C € IP54		
	dimensions	code		power Led	total absorbtion	lumen lamp
		bianco white	nero black			
parete soffitto wall ceiling	∅ 27x5,3 cm - ∅ 10,6x2 in	LD0131B3	LD0131G3	23,8W	25W	1800lm
	∅ 34x5 cm - ∅ 13,3x1,9 in	LD0132B3	LD0132G3	27,3W	30W	2200lm
	27x27x5,3 cm - 10,6x10,6x2 in	LD0136B3	LD0136G3	23,8W	25W	1800lm
	34x34x5 cm - 13,3x13,3x1,9 in	LD0137B3	LD0137G3	27,3W	30W	2200lm





Lichtinstallation 2015 by Julia Bornefeld,
visual artist Berlin (D) / Italien (I)
www.juliabornefeld.com

Lamps

Box *page 144*

Lucca *page 145*

Sferis (customized) *page 146*

Customer CG Deutsche Wohnen GMBH
curated by Anja Gröner

Location Stairwell/ LKG CARRE', Leipzig (D)







Hotel Monte Sella
San Vigilio di Marebbe



LDSK01

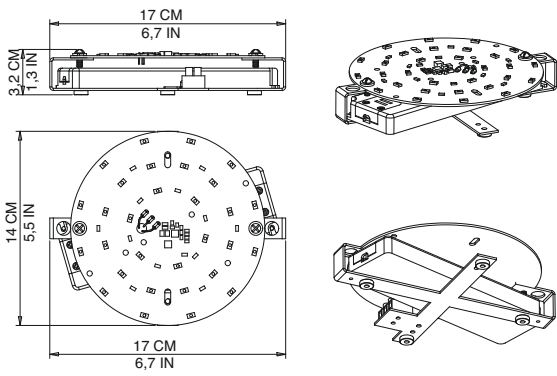

LDSK02

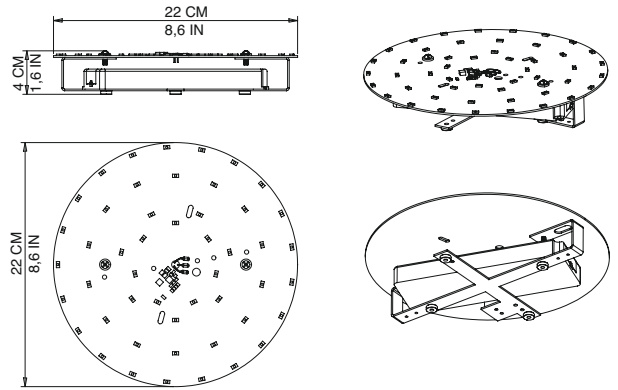

LDSK03

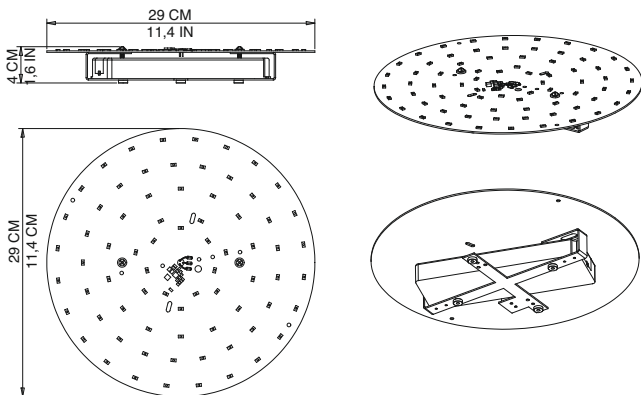

LDSK04

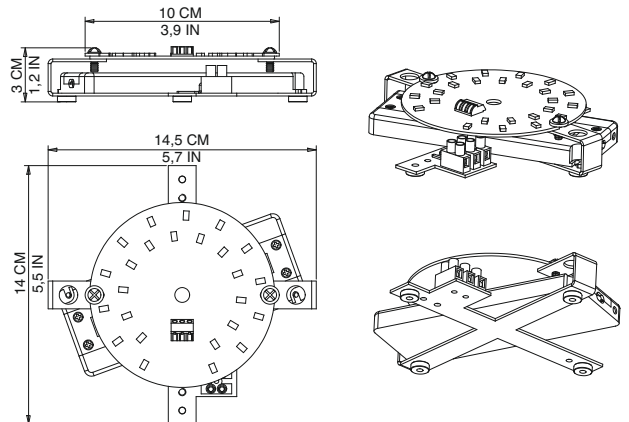









Relamping kit

Attacco con magneti o con viti
Fixing with magnets or screws

code	relamping kit	alloggiamento kit minimo su superficie circolare min. housing for kit on a circular surface	alloggiamento kit minimo su superficie rettangolare min. housing for kit on a rectangular surface	
LDSK01	modulo ø 14 cm - module ø 5,5 in 16W	ø 18 h 3,5 cm - ø 7 h 1,3 in	15x18 - h 3,5 cm - 5,9x7 h 1,3 in	16W - 1502lm - 3000K con magneti - with magnets
LDSK02	modulo ø 22 cm - module ø 8,6 in 25W	ø 23 h 3,5 cm - ø 9 h 1,3 in	23x23 h 3,5 cm - 9x9 h 1,3 in	25W - 2117lm - 3000K con magneti - with magnets
LDSK03	modulo ø 29 cm - module ø 11,4 in 41W	ø 30 h 3,5 cm - ø 11,8 h 1,3 in	30 x 30 h 3,5 cm - 11,8x11,8 h 1,3 in	41W - 3791lm - 3000K con magneti - with magnets
LDSK04	modulo ø 10 cm - module ø 3,9 in 13W	ø 15 h 3,5 cm - ø 5,9 h 1,3 in	15x15,5 h 3,5 cm - 5,9x6,1 h 1,3 in	13W - 911lm - 3000K in c.c. con magneti - with magnets
LDSK05	modulo ø 14 cm - module ø 5,5 in DIM 1/10V	ø 18 h 3,5 cm - ø 7 h 1,3 in	15x18 h 3,5 cm - 5,9x7 h 1,3 in	0-16W - 0-1502lm - 3000K con magneti dimmerabile with magnets dimmable
LDSK06	modulo ø 22 cm - module ø 8,6 in DIM 1/10V	ø 23 h 3,5 cm - ø 9 h 1,3 in	23x23 h 3,5 cm - 9x9 h 1,3 in	0-25W - 0-2117lm - 3000K con magneti dimmerabile with magnets dimmable
LDSK07	modulo ø 29 cm - module ø 11,4 in DIM 1/10V	ø 30 h 3,5 cm - ø 11,8 h 1,3 in	30x30 h 3,5 cm - 11,8x11,8 h 1,3 in	0-41W - 0-3791lm - 3000K con magneti dimmerabile with magnets dimmable
LDSK11	modulo ø 14 cm - module ø 5,5 in EMERG 1H	ø 32 h 7 cm - ø 12,6 h 2,7 in con LED di segnale (senza LED di segnale h 3,5 cm) with LED signal (without LED signal h 1,3 in)	ø 28x18 h 7 cm - ø 11x7 h 2,7 in con LED di segnale (senza LED di segnale h 3,5 cm) with LED signal (without LED signal h 1,3 in)	4-16W - 320-1502lm - 3000K con magneti con kit emergenza with magnets with emergency kit
LDSK12	modulo ø 22 cm - module ø 8,6 in EMERG 1H	ø 32 h 7 cm - ø 12,6 h 2,7 in con LED di segnale (senza LED di segnale h 3,5 cm) with LED signal (without LED signal h 1,3 in)	ø 28x23 h 7 cm - ø 11x9 h 2,7 in con LED di segnale (senza LED di segnale h 3,5 cm) with LED signal (without LED signal h 1,3 in)	6-25W - 470-2117lm - 3000K con magneti con kit emergenza with magnets with emergency kit
LDSK13	modulo ø 29 cm - module ø 11,4 in EMERG 1H	ø 32 h 7 cm - ø 12,6 h 2,7 in con LED di segnale (senza LED di segnale h 3,5 cm) with LED signal (without LED signal h 1,3 in)	ø 32x30 h 7 cm - ø 12,5x11,8 h 2,7 in con LED di segnale (senza LED di segnale h 3,5 cm) with LED signal (without LED signal h 1,3 in)	12-41W - 760-3971lm - 3000K con magneti con kit emergenza with magnets with emergency kit
LDSK14	modulo ø 50x40 cm - module ø 1,9x1,6 in 1x4W LED			4W - 420lm - 2900K con magneti con kit emergenza with magnets with emergency kit
LDSK15	modulo ø 70x40 cm - module ø 2,7x1,6 in 1x8W LED			8W - 750lm - 2900K con magneti con kit emergenza with magnets with emergency kit

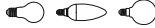
Tabella sintetica della maggior parte delle lampadine utilizzabili per gli apparecchi di questo catalogo. I dati sono da considerare indicativi e rimandiamo alle specifiche tecniche delle case produttrici. Led: l'attuale rapido sviluppo della tecnologia led permette inoltre la sostituzione in alternativa di molteplici lampade tradizionali.

Table of most bulbs used for equipment in this catalog. Information is only indicative, please refer to the technical specifications of the manufacturers. The current rapid development of led technology also allows the replacement of many bulbs.

lamp connection		Watt max	lumen lamp
alogene a risparmio energetico <i>halogen energy saver</i>			
E14		28	415
		42	720
E27		52	940
		70	1340
		105	2160
G9		33	460
R7s		120	3000
lampade fluorescenti integrate <i>fluorescent integrated lamp</i>			
E14		7	286
		8	400
E27		9	480
		12	600
		15	900
		20	1200
		23	1500
		27	1800
		33	2250
E27 E14	LED		
lampade fluorescenti compatte e lineare non integrate <i>compact and linear fluorescent not integrate lamp</i>			
G24q-3		26	1800
Gx24q-3		32	2400
2G10		24	1700
		36	2800
2G11		24	1800
		36	2900
		55	4800

Le immagini sono puramente indicative; forme e colori possono differire sensibilmente dall'originale a causa della ripresa fotografica e il sistema di stampa. Tutti i modelli rappresentati possono subire nel tempo variazioni senza preavviso; prima di eseguire un ordine d'acquisto contattare l'azienda per accertarne la corrispondenza. Tutti i diritti riservati Zafferano, riproduzione vietata se non espressamente autorizzata.

All pictures and descriptions are not binding, therefore, in order to upgrade the fixtures it produces. Zafferano srl, reserve the right, without prior notice, to make any changes it deems necessary regarding manufacturing techniques and design. The sizes, weights and colors, included the technical data sheets are subject to slight changes owing to the special workmanship that distinguishes the glass items.

Simboli *Simbols*

IP20 **Grado di protezione IP** *IP protection degree*

Le due cifre dopo la sigla IP identificano il grado di protezione contro l'intrusione di corpi solidi e liquidi
The two sets of numbers after the heading IP identify the protection degree against the intrusion of solids and liquids.

Prima cifra *First identification number*

- 0 - Nessuna protezione *Non-protected No special protection*
- 1 - Protezione da oggetti solidi maggiori di 50 mm *Protection by solid objects with diameter > 50 mm*
- 2 - Protezione da oggetti solidi maggiori di 12 mm *Protection by solid objects with diameter > 12 mm*
- 3 - Protezione da oggetti solidi maggiori di 2,5 mm *Protection by solid objects with diameter > 2,5 mm*
- 4 - Protezione da oggetti solidi maggiori di 1 mm *Protection by solid objects with diameter > 1 mm*
- 5 - Protezione da polveri *Protection by dusts*
- 6 - Protezione forte da polveri *Protection by intensive dusts*

Seconda cifra *Second identification number*

- 0 - nessuna protezione *Non-protected No special protection*
- 1 - Protezione da gocce d'acqua *Protection by water drops*
- 2 - Protezione da gocce d'acqua deviate fino a 15° *Protection by water drops with angle 15°*
- 3 - Protezione da vapori d'acqua *Protection by steams*
- 4 - Protezione da spruzzi d'acqua *Protection by water sprays*
- 5 - Protezione da getti d'acqua *Protection by water jets*
- 6 - Protezione da getti forti d'acqua o mareggiate *Protection by intensive water jets or storms*
- 7 - Protezione contro l'immersione *Protection by immersion*
- 8 - Protezione contro l'immersione continua *Protection by continuous immersion*

 L'apparecchio non può essere usato su superfici infiammabili.
The fixture cannot be used on flammable surfaces.

CE Tutti i prodotti descritti nel catalogo sono rispondenti ai requisiti essenziali delle direttive 73-23- CEE, 93-68-CEE, 89-336-CEE.
All the products listed in the catalogue are in compliance with the fundamental requisites of the directives EEC 73-23, EEC 93-68, EEC 89-336.

 Classe 2 *Class 2*

cm Unità di misura in centimetri *Unit of measure centimeters*

in Unità di misura in inch *Unit of measure inches*



zafferanoitalia.com

Zafferano srl
Viale dell'Industria, 26
31055 Quinto di Treviso
Treviso - Italia
T +39 0422 470344
F +39 0422 470400
sales@ailatilight.it



**BESPOKE
GLASS
LIGHTING**



ailatilight.it

Are brands of ZAFFERANO srl

ailatilight.it